



Certificate of Conformity

We **Kaivac, Inc.**
401 S. Third Street
Hamilton, OH 45011 USA

Declare and Certify that the following product

Machine	
Type/Model	
Serial Number	
Date of Manufacture	

Has been manufactured using the following standards and specifications:
And has been inspected and tested at our works in accordance with the relative specifications and drawings with which they comply in all respects:
And has been affixed with the CE Mark in Compliance with the following standards and specifications:

- BS EN 292-1:1991 Safety of Machinery - Basic concepts, general principles for design. Part 1: Basic terminology, methodology.*
- BS EN 292-2:1991 Safety of Machinery - Basic concepts, general principles of design - Part 2: Technical principles and specifications.*
- BS EN 614-1:1995 Safety of Machinery - Ergonomic design principles - Part 1: Terminology and general principles.*
- BS EN 1050:1996 Safety of Machinery - Principles for risk assessment*
- BS EN 60204-1:1993 Safety of Machinery - Electrical equipment of machines - Part 1: Specification for general requirements.*

and complies with the requirements of:

European Machinery directive 98/37/EC
UK Regulation 1992 no. 3073 - Supply of Machinery (Safety) Regulations 1992, and as amended.

European Low Voltage Directive 73/23/EC and as amended by 93/68/EC.
UK Regulation 1994 no.3260 - Electrical Equipment (Safety) Regulations 1994.

Place of Issue	401 S. Third Street, Hamilton, OH 45011 USA
Date of Issue	
Signature	
Printed Name	
Position	Quality Manager

Winterize your Kaivac Equipment

Your Kaivac machinery should be winterized between uses if it is to be exposed to freezing temperatures. To winterize your machine, pour 1/2 gallon of windshield wiper fluid into the empty water tank. Aim the spray gun into the water tank. Run the pump and spray the gun until the fluid begins running through.



Filter Screen Cleaning Procedure

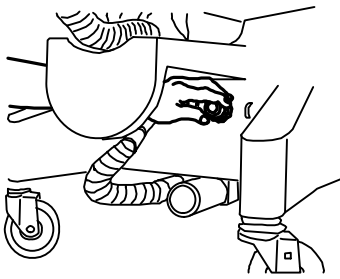

KaiVac filter is located on the base below the vac hose wrap on front of machine.

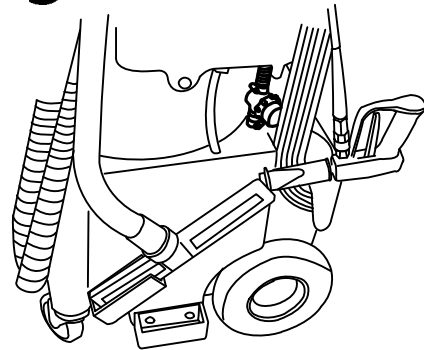

KaiZen filter is located on the left side of machine between water supply tank and the hood assembly.

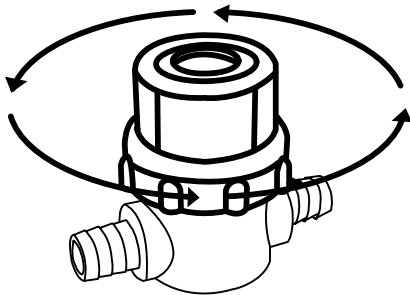

Rotate bowl cover counterclockwise to remove.

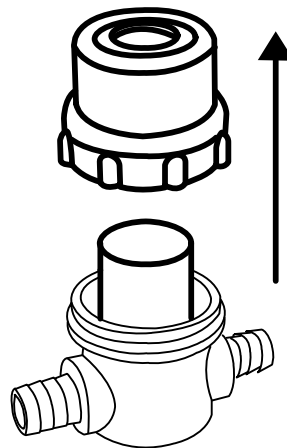

Lift bowl cover up and remove.

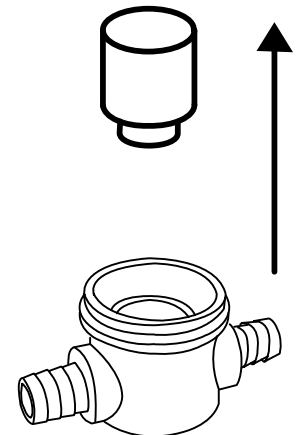

Pull filter up and out.

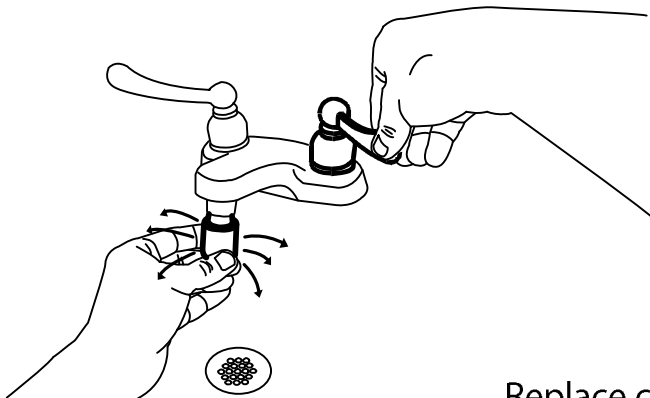

Place filter screen with the open end up against spout of sink fixture or water source and turn on the water flushing debris from the inside out. Continue flushing until water flows freely thru filter. Filter is clean if one can blow freely thru it.

Replace cleaned filter reversing the procedure above. If filter cannot be cleaned replace with new one.

DO NOT OPERATE MACHINE WITHOUT FILTER.



KaiZen[™]

No-Touch Cleaning[™]

Protected by U.S. Patent # 6,206,980; patents pending

Operator and Parts Manual

SERIAL# 3308 TO 3672

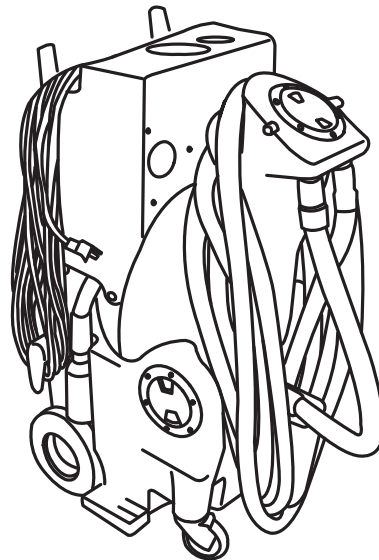

Kaivac, Inc.
401 S. Third St.
Hamilton, OH 45011

Phone: (513) 887-4600
Toll Free: (800) 287-1136
Fax: (513) 887 - 4601

www.kaivac.com



© 2005 Kaivac, Inc. All Rights Reserved



Warranty Registration Form

Free gift with completion of form

To be completed and mailed or faxed by the customer purchasing equipment.
Return this warranty card within ten days of purchase.

Purchased By:

Name _____ Title _____

Company _____

Street Address _____

City _____ State _____ Zip Code _____

Phone Number _____ Fax _____

Date Purchased _____ Name of Distributor _____

KaiVac® KaiZen™
Serial Number _____

Does your system include a KaiTutor™? Yes No

Type of Business

- | | |
|---|--------------------------------------|
| <input type="checkbox"/> School/University | <input type="checkbox"/> Industrial |
| <input type="checkbox"/> Hospital/Health Care | <input type="checkbox"/> Office |
| <input type="checkbox"/> Contract Cleaner | <input type="checkbox"/> Other _____ |

Intended Uses (check all that apply):

- | | | |
|--|--|---|
| <input type="checkbox"/> Restroom Cleaning | <input type="checkbox"/> Cleaning Around Machinery | <input type="checkbox"/> Classroom Cleaning |
| <input type="checkbox"/> Floor Stripping | <input type="checkbox"/> Stairwell Cleaning | <input type="checkbox"/> Other _____ |
| <input type="checkbox"/> Kitchen Cleaning | <input type="checkbox"/> Locker and Shower Room | |
| <input type="checkbox"/> Carpet Extraction | <input type="checkbox"/> Hallway Cleaning | |

Thank you very much for the information you have filled out for our records. As our way of saying thank you, we'd like to send you a free Microfiber KaiTowel.

Kaivac, Inc. · 401 South Third St. · Hamilton, Ohio 45011
Phone (513) 887-4600 · Fax (513) 887-4601 · Toll Free (800) 287-1136 · www.kaivac.com

READ FIRST

INSTALL DATE

Please fill out card for future records

Install date- _____
Serial No.- _____

Read this manual prior to operation.

This machine will operate at its optimal efficiency if:

- The machine is operated as described in this manual.
- The machine is maintained properly and regularly-per maintenance instructions.
- The machine is maintained with manufacturer parts only.

Carefully unpack and inspect your new KaiZen cleaning machine for shipping damage. Each unit is tested and thoroughly inspected before shipping. For instructions regarding shipping damage, contact Kaivac, Inc. immediately. All returns must have a Return Authorization Number (RAN), which is available by calling the Kaivac, Inc. Customer Service Department. Remember to protect your investment by registering your Warranty online at www.kaivac.com or mailing in the form on page iii.

TABLE OF CONTENTS

WARRANTY REGISTRATION FORM.....	iii
READ FIRST/TABLE OF CONTENTS.....	v
INTRODUCTION.....	vii
SAFETY PRECAUTIONS.....	1-2
LIMITED WARRANTY PROTECTION PLAN.....	3
MACHINE COMPONENTS/PREPARATION.....	4
S·I·M·P·L·E PROCESS.....	5-20
MACHINE MAINTENANCE.....	21
TROUBLESHOOTING.....	22-24
CHEMICAL INJECTION.....	25
FLOW/ELECTRICAL DIAGRAMS.....	26
PARTS LIST.....	27-30
FIG.1 - WATER TANK ASSEMBLY.....	31
FIG.2 - VAC TANK.....	32
FIG.3 - COVER/PUMP MOTOR.....	33
FIG.4 - COVER/PUMP MOTOR - KAIZEN PLUS.....	34
FIG.5 - DVD/SWITCH PLATE - KAITUTOR.....	35

INTRODUCTION

INSPECTION

Carefully unpack and inspect your new KaiZen cleaning machine for shipping damage. Each unit is tested and thoroughly inspected before shipping. For instructions regarding any shipping damage, contact Kaivac, Inc. immediately. All returns must have a Return Authorization Number (RAN), which is available by calling the Kaivac, Inc. Customer Service Department.

WARNINGS

- **DO NOT** operate with a frayed, worn or damaged electrical cord.
- **DO NOT** use to pick up flammable or combustible materials.
- **DO NOT** run the pump without water in the water tank or without filter.
- **DO NOT** use hot water.
- **DO NOT** remove the float shutoff.
- **ALWAYS** test chemicals for compatibility on surfaces to be cleaned.
- **ALWAYS** winterize your Kaivac equipment between uses if it will be exposed to freezing temperatures.

GROUNDING INSTRUCTIONS

THE KAIZEN MUST BE GROUNDED. If it should malfunction or stop working, grounding provides a path of least resistance for the electrical current and reduces the risk of electrical shock. The KaiZen is equipped with a ground fault circuit interrupter (GFCI) to further reduce danger of electric shock. **It must be maintained and tested regularly.** An equipment grounding cord and plug is included with the unit. The plug must be inserted in an appropriate outlet that has been properly installed and grounded in accordance with all local codes and ordinances. Cutting off the ground wire or using a cord with an ungrounded plug will void the warranty on the unit, and Kaivac, Inc. will NOT accept responsibility for the unit.

Improper connection of the equipment grounding cord can result in the risk of electrical shock. Ask a qualified electrician or service person to check the outlet grounding if you are unsure. Do not modify the plug provided with the KaiZen. If it will not fit the outlet, have a properly grounded outlet installed by a qualified electrician.

SAFETY PRECAUTIONS

- **Equipment Warning**
 - Read all instructions to ensure safe operation of the KaiZen.
- **Training**
 - Proper training is required before using the KaiZen. Contact your authorized Kaivac distributor for training information.
 - Instruction placards are attached to each KaiZen and should not be removed. These placards show proper cleaning procedures and safety precautions.
- **Equipment Use**
 - Use the equipment for the purposes specified by the manufacturer. Do not use the equipment for any other purpose.
 - See the S-I-M-P-L-E Operation section for proper use of the equipment.
- **Spray Gun**
 - Never point the spray gun at people.
- **Prevention of Electrocutation**
 - Use the ground fault circuit interrupter (GFCI) with the KaiZen at all times.
 - Test the GFCI before each use.
 - Do not spray liquid from the KaiZen onto electrical outlets or on any electrical devices.
- **Personal Protection**
 - Wear gloves, eye protection and ear protection when operating the KaiZen.
- **Machine Integrity**
 - Do not run the pump dry. This will void the machine warranty.
 - Do not run hot water through the pump. This can cause pump cavitation and will void the warranty.
 - Always be sure the water tank and water line filters are clear of debris. Running the pump with clogged filters can cause pump damage.
 - Replace any damaged cords before use.

- **Winterize Your Kaivac Equipment**

Your Kaivac machinery should be winterized between uses if it is to be exposed to freezing temperatures.

- To winterize your machine:
 - Pour 1/2 gallon of windshield wiper fluid into the empty water tank.
 - Aim the spray gun into the water tank.
 - Run the pump and spray the gun until the fluid begins running through.

- **Chemical Use**

- Only use chemicals approved for use with the KaiZen. Use of non-Kaivac chemicals may cause machine damage and will reduce warranty periods.
- Turn chemical line off when not in use.
- Keep the appropriate chemical MSDS sheets on hand at all times.
- Cleaning chemicals should not be put in the water tank (with the exception of KaiDri in small amounts). Chemicals in the water tank can harm operator and machine because:
 - Chemicals in the water tank must pass through the pump, which may cause premature pump failure.
 - Use of chemicals in the water tank voids the warranty.
 - Chemicals in the water tank will be aerosolized and may harm the operator.

- **Electrical**

- Connect to a properly grounded outlet only.
- Do not pull the KaiZen by the cord or use the cord as a handle.
- Do not close a door on the cord or pull the cord around sharp edges or corners.
- Do not run over the cord.
- Keep the cord away from heated surfaces.
- Turn off the unit before unplugging.
- Do not pull on the cord to unplug. Grasp the plug at the outlet and pull.

- **Prevention of Water Damage to Buildings**

- The KaiZen is to be used on water resistant building surfaces only. These include concrete, terrazzo, ceramic tile and quarry tile.
- The KaiZen may be used for stripping on vinyl composite tile floors, but daily cleaning of resilient flooring using the KaiZen is not recommended.
- Never overflow the water tank or the vacuum recovery tank.
- Discontinue use if any leaks occur in the KaiZen.

CAUTION: Prior to cleaning, always inspect area to ensure that the surfaces to be cleaned are water-safe. In addition, check for poor construction, damaged walls and floors, missing or damaged tiles or grout, missing or insufficient caulk, and loose wall coverings. If problems are discovered, resolve them prior to cleaning in order to avoid any harm that may result from exposure to water or cleaning solution.

SAVE THESE INSTRUCTIONS

Violation of any of these instructions may void any and all warranties

Limited Warranty Protection Plan

The KaiZen has been engineered and tested to provide long lasting performance. This warranty covers defects in workmanship or materials under normal use and service from the date of purchase.

Kaivac, Inc. warrants the following components to be free from defects in materials and workmanship for these time periods:

1.) KaiChem Warranty for end users who use only Kaivac chemicals for the life of the machine.

- 5 years on rotationally molded parts
- 3 years on other parts (excluding wear items)
- 1 year on labor

2.) Standard Warranty (for approved non-Kaivac chemicals)

- 1 year parts and labor

3.) Chemicals that have not been approved by Kaivac.

If uncertain, please call Kaivac to check.

- No warranty

*** The parts in question must be returned to Kaivac for inspection by our warranty department. Return part(s) to: Kaivac, Inc.**

230 Sycamore St. Hamilton, OH 45011

Attn: Allen, Warranty Dept.

All KaiZen replacement parts are guaranteed for 90 days from the date of installation. Normal wear items such as wheels, hoses, seals, gaskets, cords, casters, squeegees and GFCI are excluded from warranty coverage.

All warranty claims must be accompanied by a Return Authorization Number (RAN), which is available by calling the Kaivac, Inc. Customer Service Department. No returns will be accepted without a RAN.

This warranty does not apply to return freight costs, damage or defect caused by accident, negligence, misuse, fire or repair done by anyone other than a Kaivac authorized repair center. In no event shall Kaivac, Inc. be liable for incidental or consequential damages, or any damages to persons or property.

Please Note: Under no circumstances will the seller be liable for any loss, damage, expenses or consequential damages arising in connection with the use or inability to use seller's product. Kaivac, Inc. reserves the right to make changes or improvements to its equipment without notice. Some states do not allow the exclusion or limitation of incidental or consequential damages. This warranty is in lieu of any other warranty expressed or implied, including any warranty of merchantability or fitness for a particular purpose.

MACHINE COMPONENTS



- 1: 14 1/2" Squeegee Head
- 2: Chemical Line
- 3: 33' Vac Hose
- 4: Vac Tank
- 5: Vac Wand
- 6: Gulper Tool
- 7: Components Hood
- 8: Water Tank
- 9: Muffler and Hose
- 10: GFCI
- 11: Blow Nozzle
- 12: Dump Hose
- 13: Pressure Gun
- 14: Electric Cord
- 15: Pressure Hose
- 16: Water Tank Lid
- 17: Vac and Pump Switches
- 18: Chemical Valve
- 19: Vac Lid
- 20: 8" Pneumatic Wheel
- 21: Metering Tip Pack
- 22: Blow Hose
- 23: Window Squeegee
- 24: Placards
- 25: Deck Brush

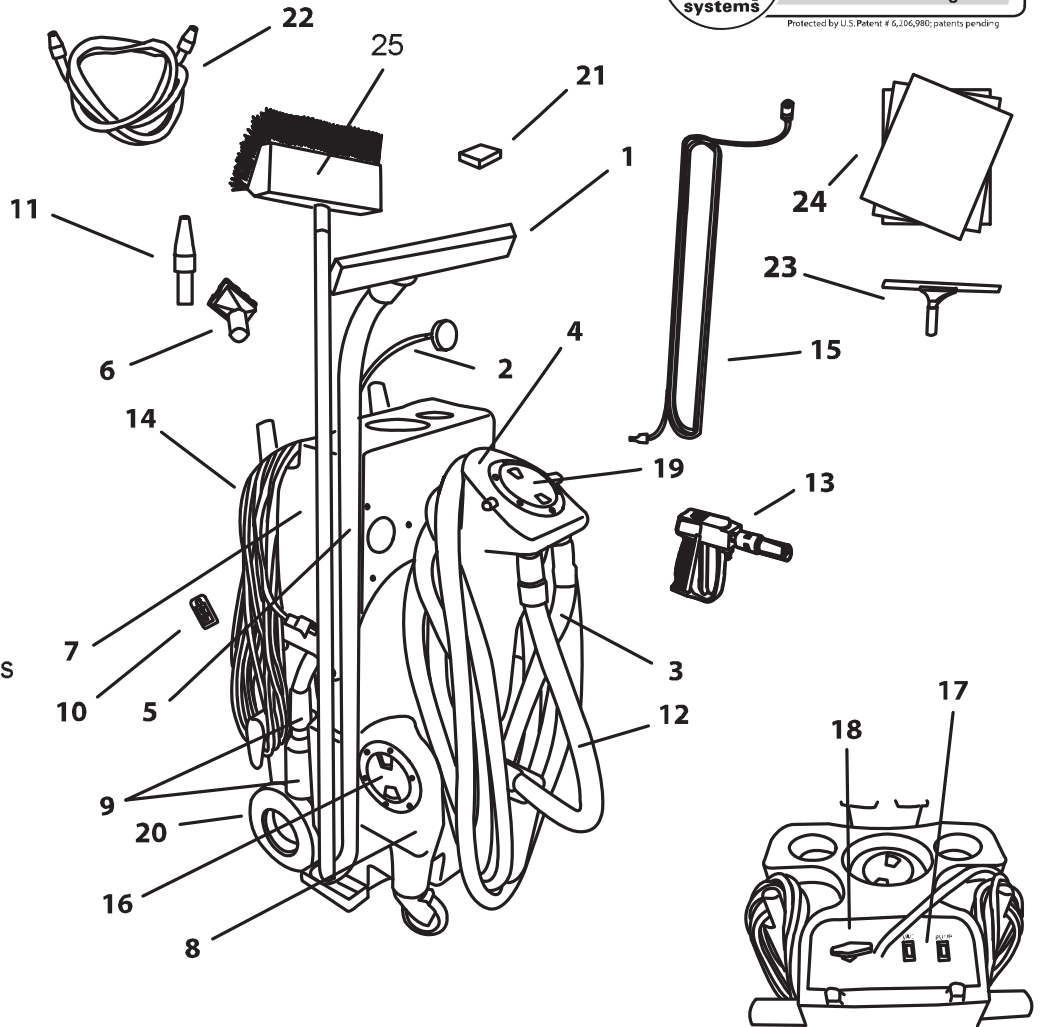

MACHINE PREPARATION

1. Fill with clean cool water.

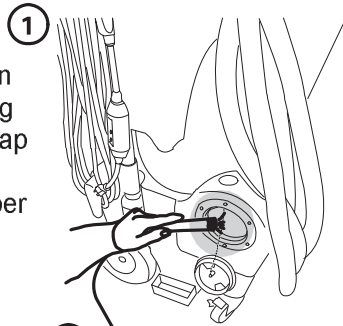

2. Prepare the cleaning solution you will be using by attaching the chemical feed line and cap to the top of your chemical bottle and selecting the proper metering tip.



3. Check machine for all tools and supplies needed to complete task.

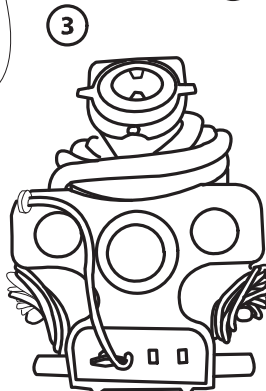

4. Check all hoses and spray lines for damage prior to starting job. If damage is found, do not continue until proper repairs are completed.

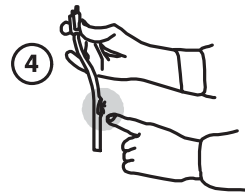

5. Test GFCI (Ground Fault Circuit Interrupter) to ensure it is working properly. You are now ready.

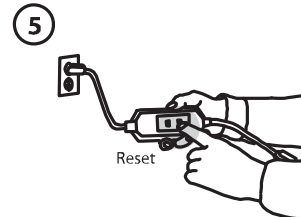



S * I * M * P * L * E TM
No-Touch Cleaning Methods

Kitchens
Stairwells
Restrooms
Tank and Hose Cleaning
KaiTricks
Vacuuming Tricks
General Maintenance
Safety
Machine Components



Technical Support Info.

www.kaivac.com



S*I*M*P*L*E

No-Touch Cleaning Method

Used in all procedures



Set-up



Fill with clean cool water

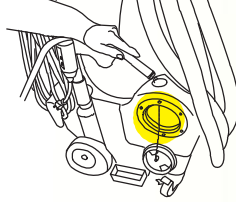

Fill Water Tank
(For KaiVac add 2 Caps of KaiDri for all others add 1 cap)

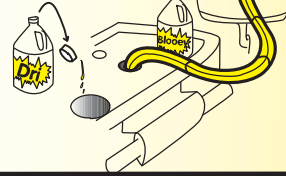

Select metering tip and insert into cap barb

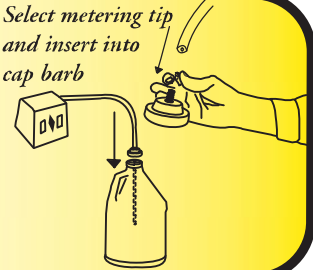

Inject Chemicals

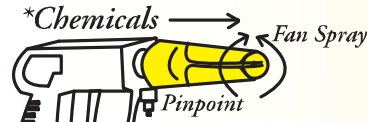

LOW Pressure Mode

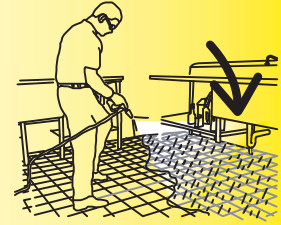

Manual Brush

(OPTIONAL)



Manually brush heavily soiled areas

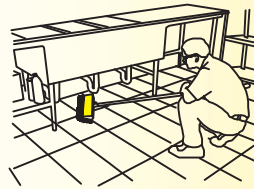

Pressure Wash & Rinse

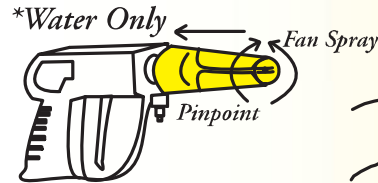

HIGH Pressure Mode

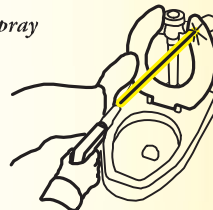

PINPOINT Spray

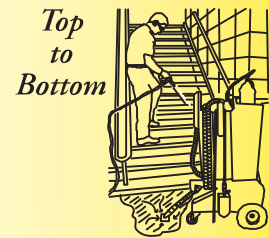

Loop Spray Line

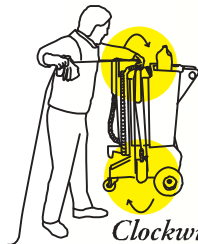
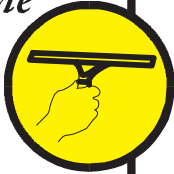

Clockwise

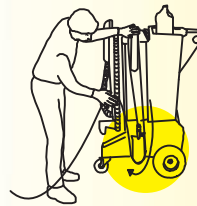

Adjust last loop (KaiVac only).

Extract & Dry

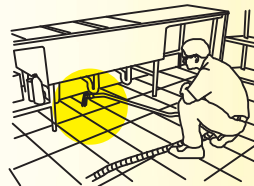

Kaivac No-Touch Restroom Cleaning

(Suggested chemical: KaiBlooey)

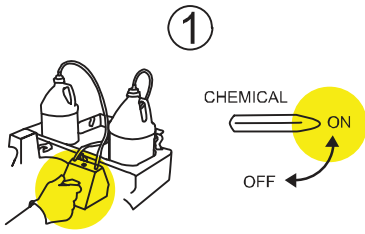

① Turn chemical valve on.
Check tank levels.
Optional:
Dust with KaiHose

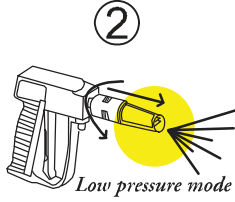

② Adjust spray gun to chemical injection.
Pull nozzle out and rotate for fan pattern.

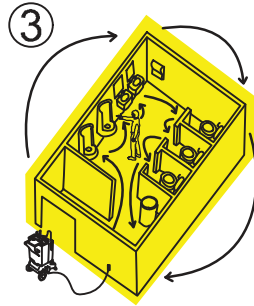

③ (Pretest chemicals on all surfaces before using.) Inject chemicals on fixtures and soiled areas. Start at the nearest fixture traveling in circular pattern.



④ 7 sec. Chemical injection



⑤ 3 sec. Chemical injection

Apply cleaning solution to fixtures.



⑥ 2 sec. chemical injection.
7 sec for high pressure rinse.

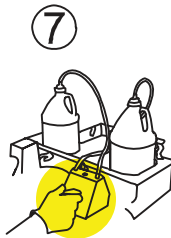

⑦ Turn chemical valve off.

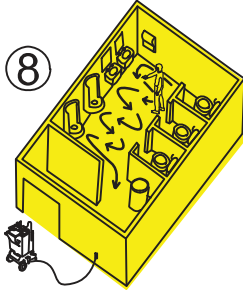

⑧ Rinse chemical from line onto floor. Optional: Manually brush heavily

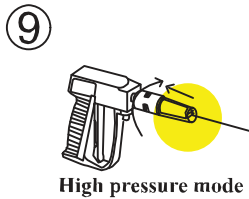

⑨ Push nozzle in and rotate to a pinpoint pattern. Adjust spray gun for high pressure wash and rinse.

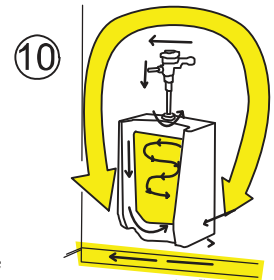

⑩ Pressure wash fixtures in a top-to-bottom pattern.
15 sec for high pressure rinse.



⑪ 6 sec. Pinpoint clean plumbing and seat top.



⑫ 6 sec. Lift seat, clean hinges and seat bottom.



⑬ Rim Shot 4 sec. Place nozzle under rim and rotate.

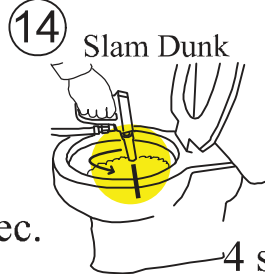

⑭ Slam Dunk 4 sec. Spray into bowl.

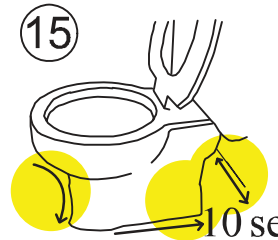

⑮ 10 sec. Spray bottom and base.
Toilet Cleaning time 30 sec. (for high pressure rinse)

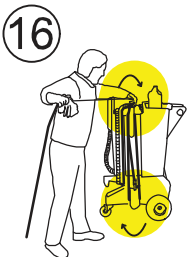

⑯ Loop and dry hose onto wraps.

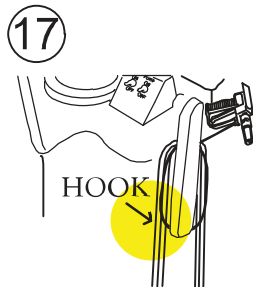

⑰ Adjust last loop. (KaiVac model only)

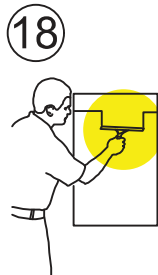

⑱ Squeegee mirrors and flat surfaces.



⑲ Wet vac restroom floor from front to rear. Load paper, supplies and examine.

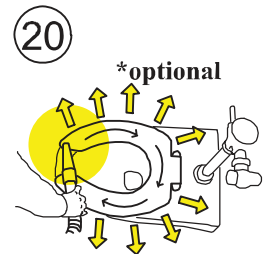

⑳ *optional Blow dry flush handles and toilet seat tops for immediate use.

Kaivac Hallway Cleaning

Method of Use

I. Apply Cleaning Solution

1. Unwrap the spray gun and pressure hose. Leave 2 loops wrapped on the No-Touch Cleaning machine.
2. Using the spray gun, apply a wide spray pattern of cleaning solution to the floor in a serpentine manner. (1 gallon covers approximately 800 feet.)
3. For daily cleaning of waxed floors, it is recommended that you use a neutral (pH7) cleaning solution, such as KaiO™ from Kaivac.

II. Vac Off

1. Connect the KaiAuto™ head to the Vac Wand and hose.
2. Start vacuuming to the right of, and away from, the No-Touch Cleaning machine, heading along the wall.
3. Proceed along the wall until you reach the limit of the hose length.
4. Turn to the left 180° heading back toward the machine with a 2" overlap of the previous pass.
5. Swerve KaiAuto towards the wall just as you pass the No-Touch Cleaning Machine (now vacuuming the wall on the left side of the machine) and continue down the hall.
6. At the end of the hose make a 180° right turn heading back towards the unit with a 2" overlap of the previous pass.
7. Continue this method until you reach the far wall away from the cleaning machine.

(Please see the training video for more information.)

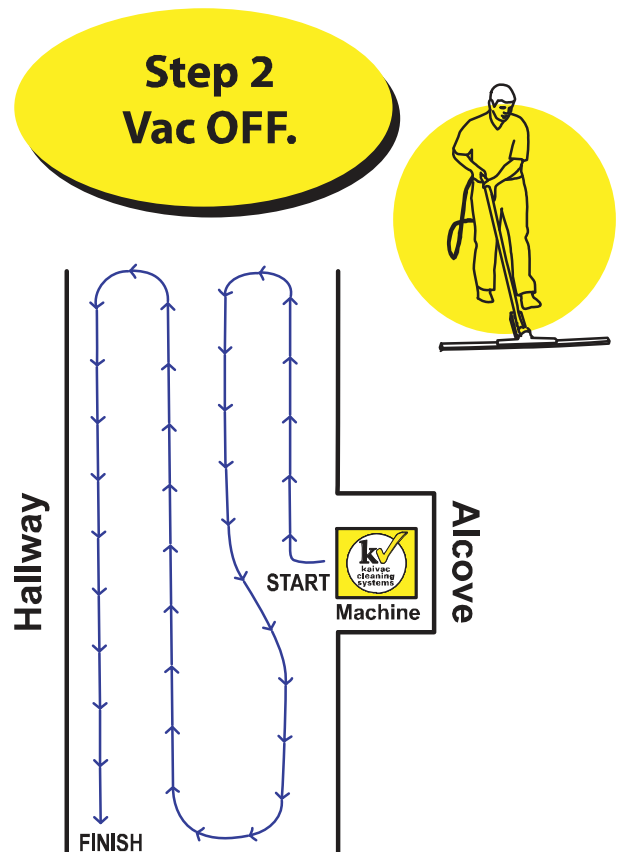
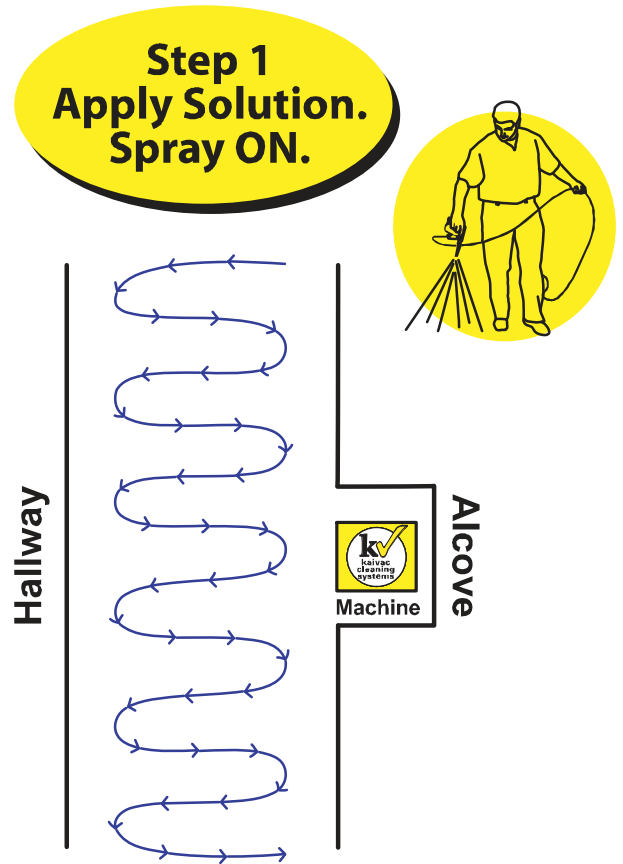

Kaivac Kitchen Cleaning

(Suggested chemical: KaiPow)



Wrap velcro in tight spiral fashion around water faucet nozzle and fill tank.

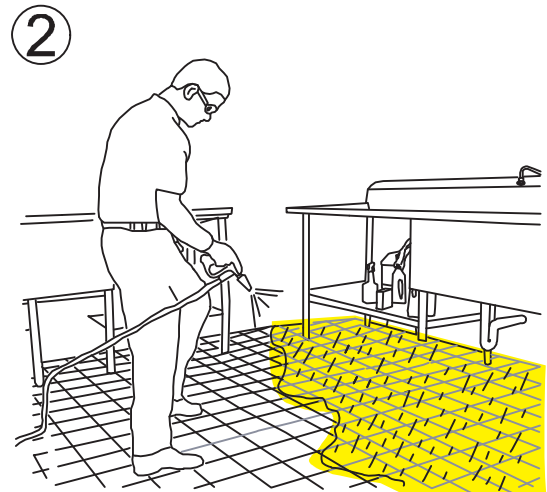

Inject chemicals on soiled surfaces and floor.

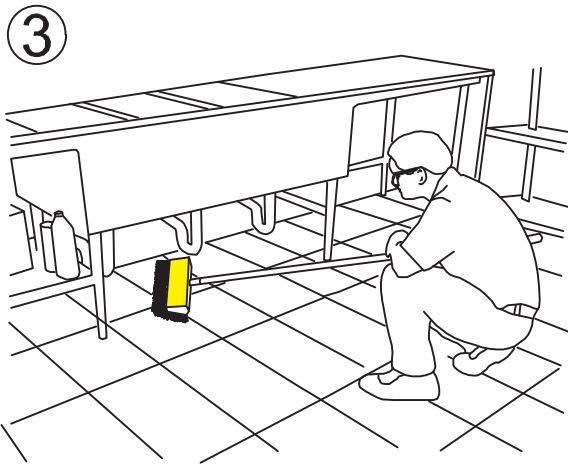

Manually brush floor in heavily soiled areas.

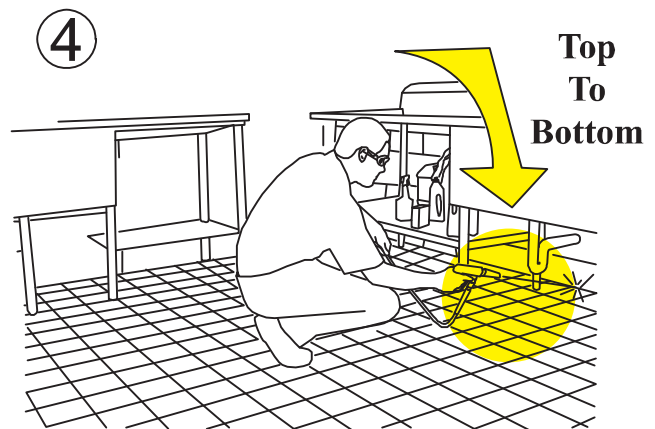

Pinpoint spray works great removing soils in corners and around base boards.

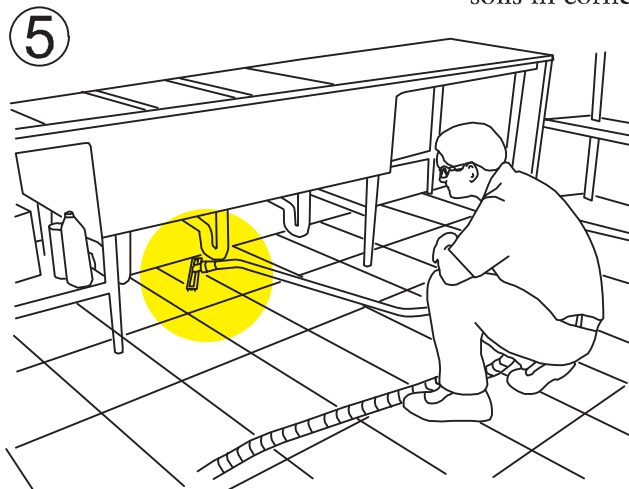

Vacuum soiled liquid from floor. Lay wand flat to maneuver under equipment and fixtures.

Kaivac KaiGrouter

Connect spray line and vac hose to KaiGrouter

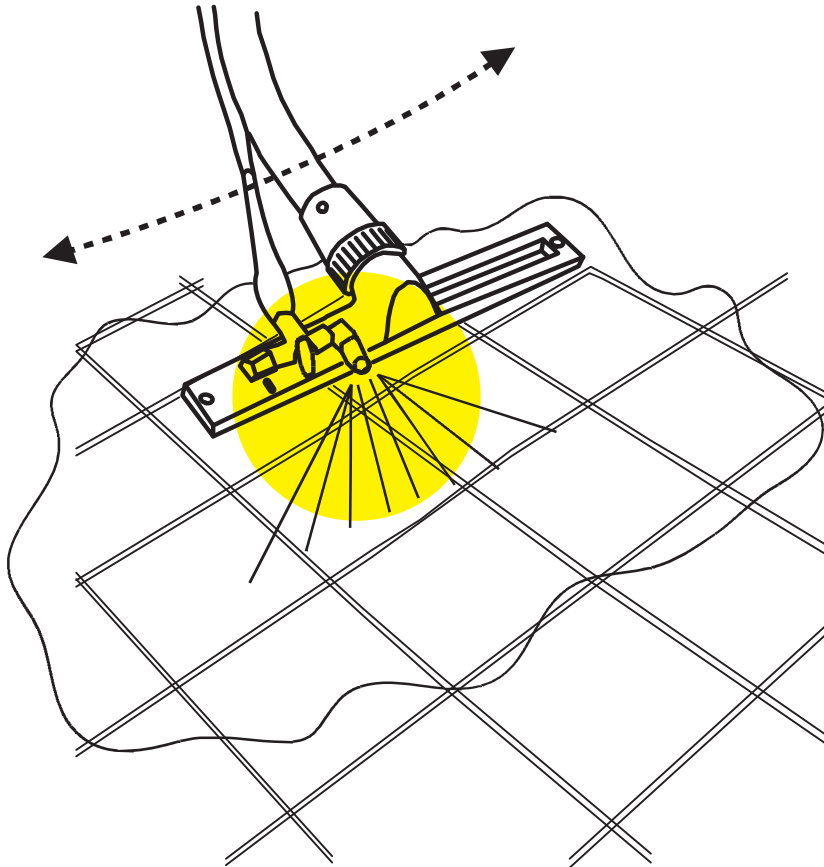

1

Turn valve to fan spray to apply chemical. Lift head off floor and move over floor spraying chemicals.

2

Turn valve to high pressure setting, line up yellow guide line with grout lines, pull trigger and move along grout line.

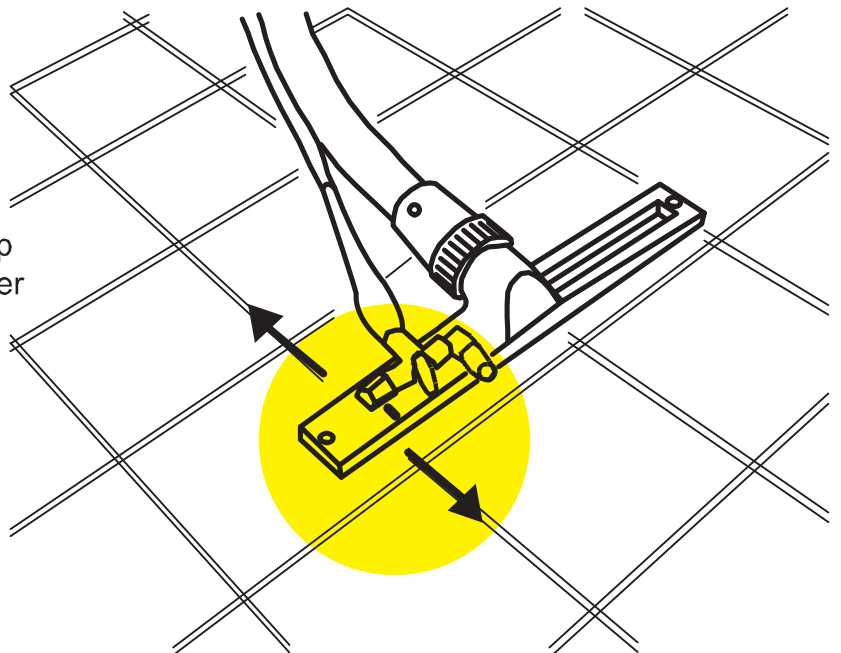

Kaivac Stairwell Cleaning

①



Insert KaiNozzle to blow-dust elevated areas.

②

Position machine at bottom of stairs. Dust cobwebs from high and hard to reach areas using KaiBlower and squeegee wand.

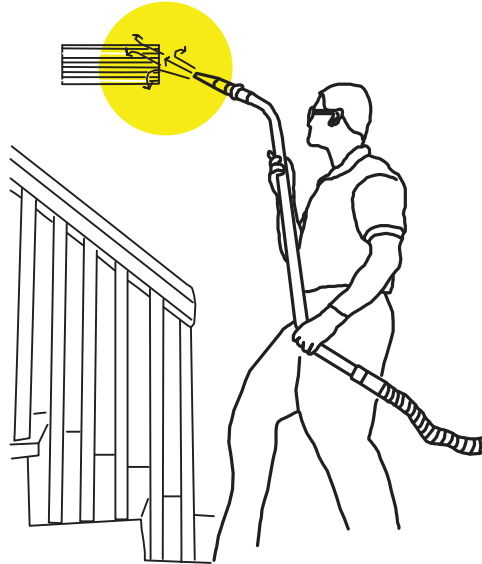

③

Position KaiDrain at bottom of steps to suction excess moisture.

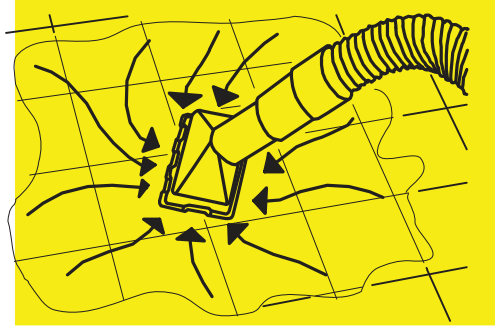

KaiDrain is an instant drain for use when puddling occurs.

④

Inject chemicals and apply to walls and stairs.

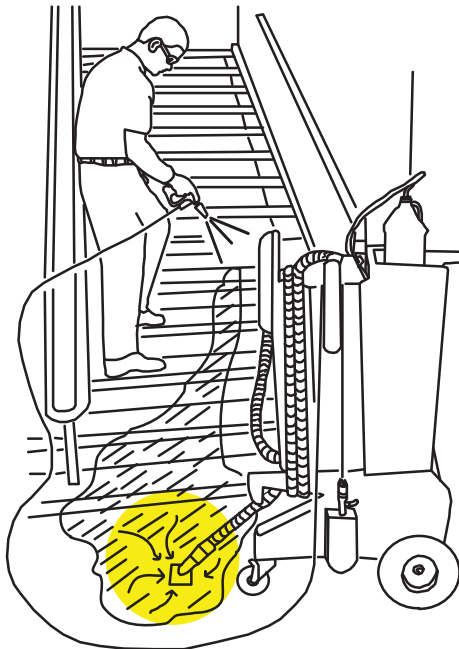

⑤

Wash and rinse with high pressure spray to remove soils. In case of heavy soils, use KaiBrush on walls and stairs.

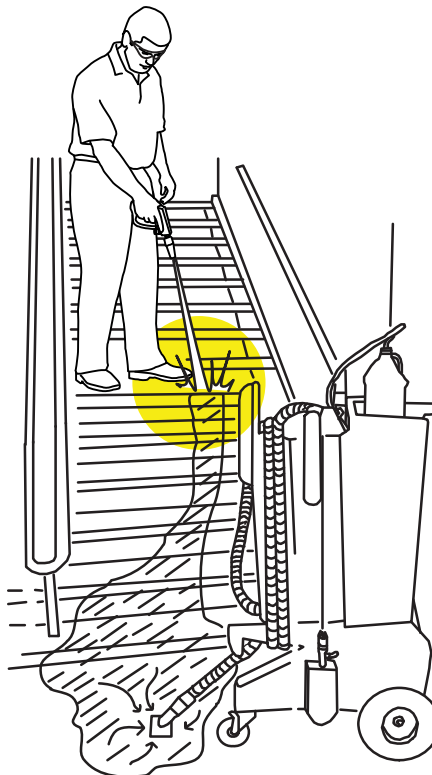

⑥

The floor squeegee tool sucks away soils and solution leaving stairwells sparkling clean. Soils are contained in the machine for later disposal.



Kaivac Tips

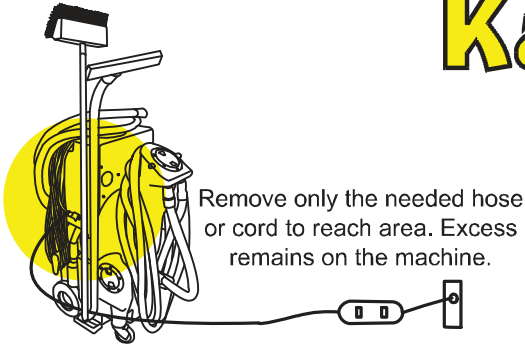

Remove only the needed hose or cord to reach area. Excess remains on the machine.

Use the wrap and snap located on the top left side of your machine to secure the gun.

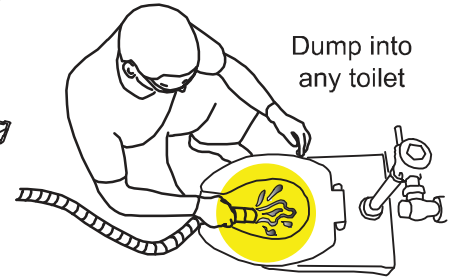
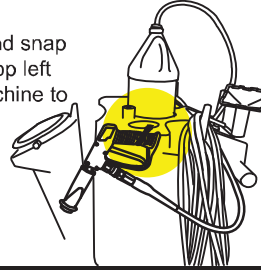

Dump into any toilet

Fill Hose

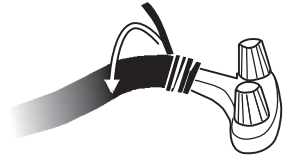

Wrap velcro in tight spiral fashion around water faucet nozzle and fill tank.

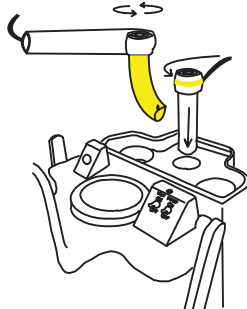

Wrap and stow the Fill Hose.

Wheel Chair



Spray proper cleaning solution on chair. Allow contact time. High pressure rinse to remove soils.

Blow dry with KaiBlower.



Blow Feature

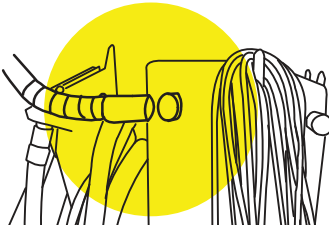

Remove blow hose from machine and attach one end to outlet on side of component hood. (KaiZen Plus model shown)

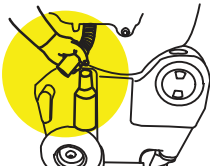

Remove exhaust hose from muffler and attach vac hose to muffler using the gray hose coupler. (Standard KaiZen)

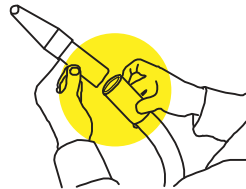
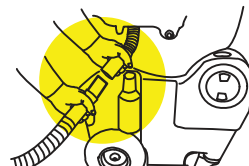

Insert KaiNozzle to blow-dust elevated areas.

Use KaiBlower for dusting and cleaning lockers.



DRY VACUUM MODE OPERATION

STEP (1)

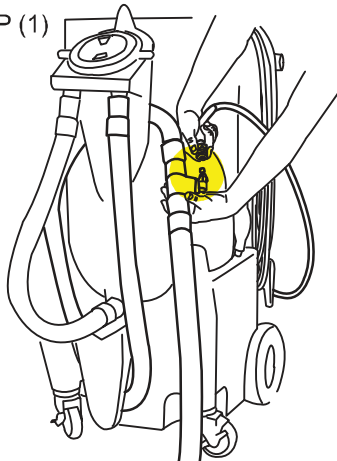

Remove spray gun from spray line. Connect to Wet/Dry Vacuum Converter.

STEP (2)

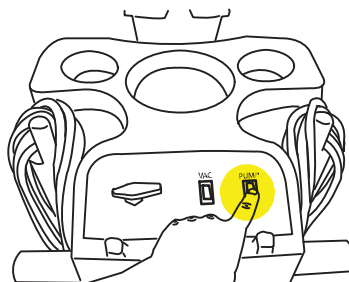

Empty vac tank, fill water tank, turn on pump and vac motor.



With appropriate cleaning tool begin cleaning.

A full water tank should clean for approximately 60 minutes before vac fills. To continue, repeat steps 1 and 2.

Kaivac Classroom Cleaning

Front Entrance Classroom

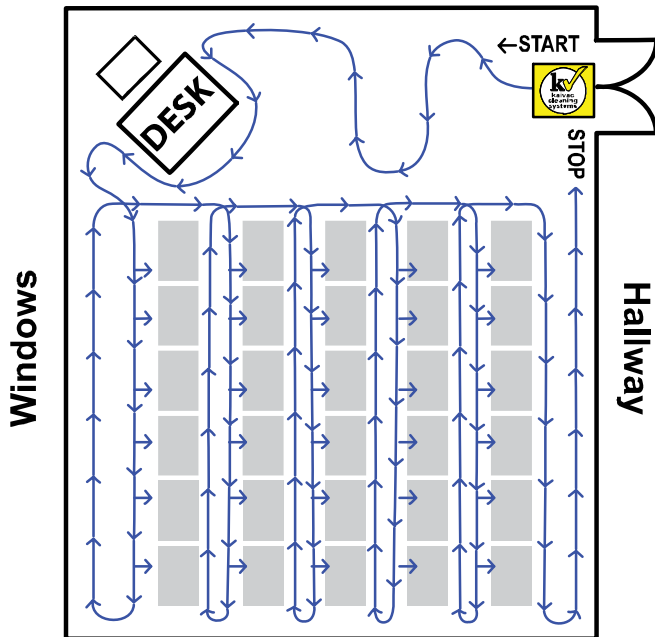

Park unit at entrance of classroom.

Cleaning Procedure

I. Daily

1. Set-up No-Touch Cleaning machine for dry vacuuming.
 - Attach Wet/Dry Converter and dry vacuum head.
 - Park unit at entrance (see illustration for location and vacuum flow pattern).
 - Plug unit into outlet.
2. Close and lock all windows.
3. Empty pencil sharpeners.
4. Pick up large debris from floor (pencils, papers, etc.) and place in trash can.
5. Empty trash can.
6. Dry vacuum as shown in illustration. Clean aisle space directly in front of you, then clean under chair next to you. Repeat until row is finished.
7. Spot clean floor with spray bottle and flat microfiber mop head.

Rear Entrance Classroom

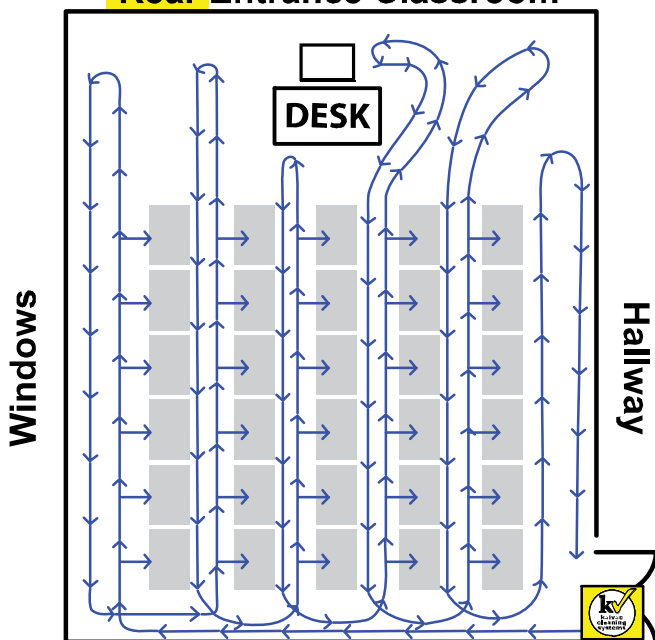

II. Weekly

1. Dry vacuum horizontal surfaces (teacher's desk, window sills, cabinets, etc.).
2. Dry vacuum computer screens.
3. Spot clean walls, desktops and windows.
4. Clean inside trash can with spray gun and instant drain (gulper tool).
5. Clean chalkboard and tray.

For oversized rear entrance classroom, park unit at front of classroom to start.

Kaivac Priming Procedure

KaiZen Plus

STANDARD PRIMING PROCEDURE

SPRAY INTO HOLE

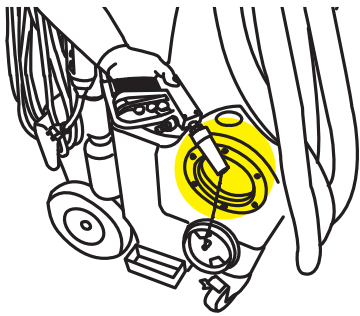

1. Fill water tank.
2. Turn pump on.
3. Pull trigger on spray gun and simultaneously squeeze Primer Bulb 5 times.
4. Repeat step 1-3 if necessary.

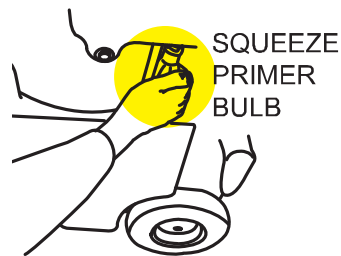

ADVANCED PRIMING PROCEDURE

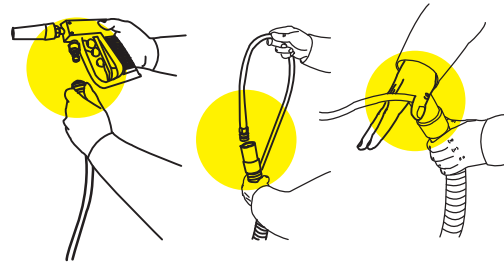

1. Disconnect spray gun and insert spray line into Vac Hose.
2. With both Vac and Pump Motor running, seal vac hose with palm.
3. At the same time squeeze Primer Bulb. Priming should occur after several tries.

KaiZen

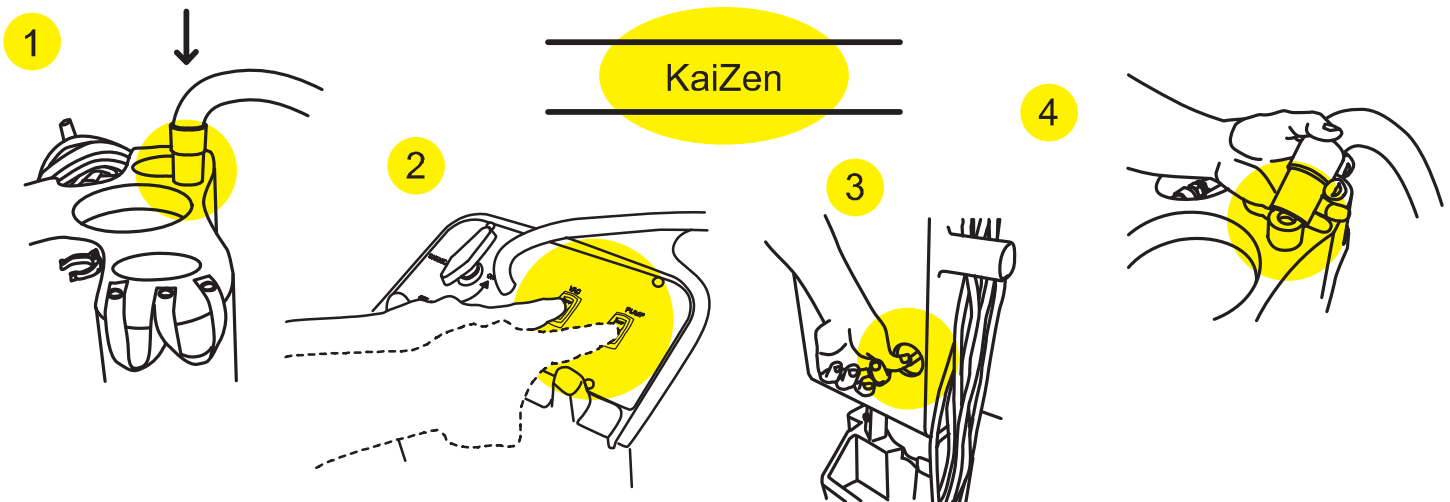

- (1) Place Vac Hose on Primer Port, (2) Turn Vac Motor on, then Pump Motor, (3) Press down on Primer Lever and hold for 5 seconds, (4) Turn off Vac Motor. If priming fails, repeat steps 1-4.

Kaivac Safety Tips

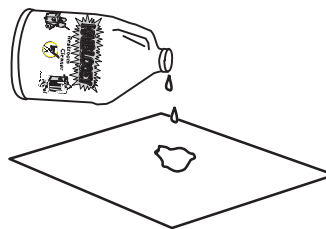

Test chemicals
on all surfaces
for compatability.

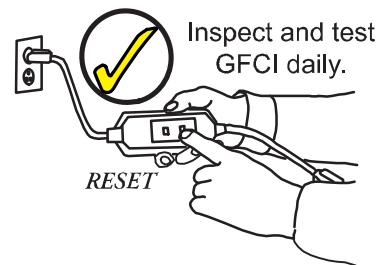
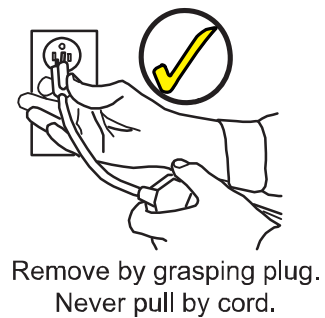

Kaivac General Maintenance

Inspect Filters for dirt.

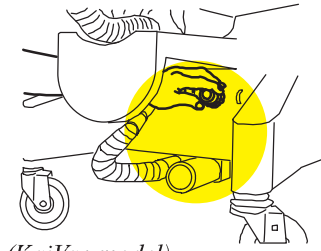

(KaiVac model)

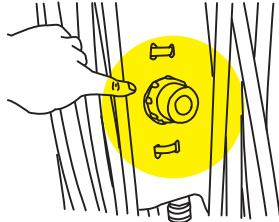

(KaiZen Model)

If found, remove cover, clean filter screen and reinstall.

Inspect Muffler for soils.

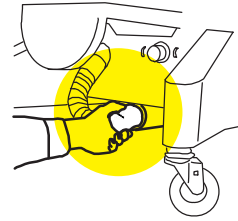

(KaiVac model)

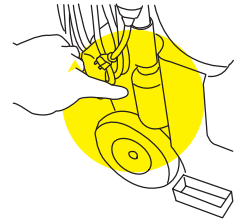

(KaiZen model)

If found, remove stuffing, wash and reinstall.

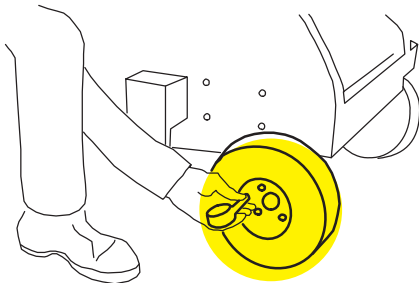

Keep tire pressure at 30 psi.

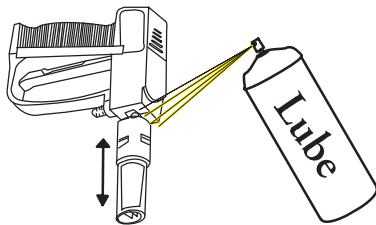

(Weekly) Lubricate nozzle with penetration oil. Nozzle must move freely forward and backwards.

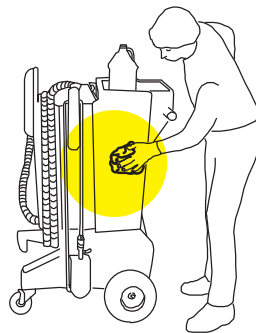

Wipe entire unit clean with an all purpose cleaner. (DO NOT PRESSURE WASH MACHINE)



Winterize system for outdoor storage or transport in sub freezing temperatures. Remove all water from tank, add 1/2 gallon windshield washer fluid. Run pump and spray until fluid is discharged from gun.

Unscrew locking collar to remove tools

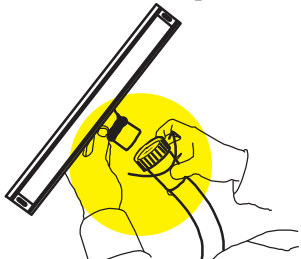

For Floor Squeegee, ensure brass ring is located in groove.

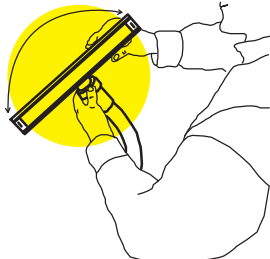

When collar is snug Floor Squeegee should rotate freely.

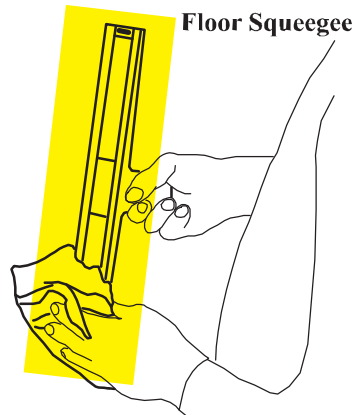

Floor Squeegee

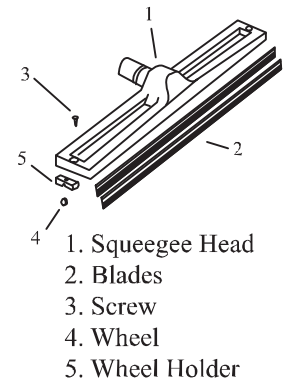

Wipe Squeegee blades with cloth. Inspect tool for worn wheels and blades. Replace as needed.
MANUAL - ZEN Rev. 03/9/05

Kaivac Tank and Hose Cleaning

1. Unwrap Vac Hose and lay it on floor.

2. Lower end of Vac Hose to surface of water, gulping both air and water. This action flushes soils from line and quickly empties water tank.

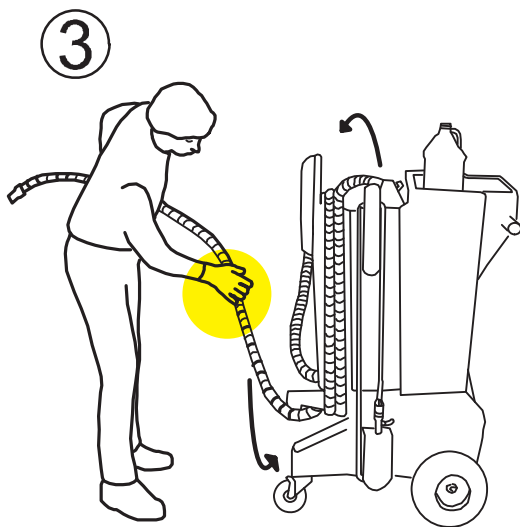
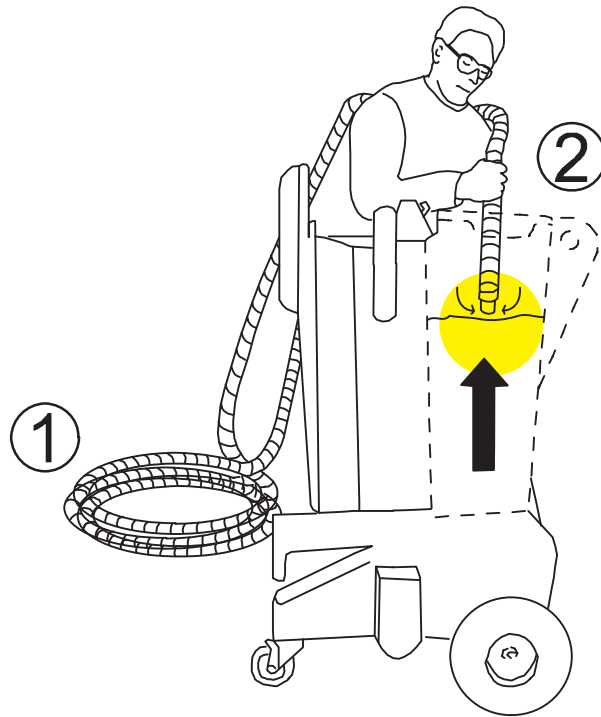

3. Vac Hose can now be wrapped onto machine. Leave vac motor running while wrapping to avoid water dripping from end of hose. To completely dry hose leave vac motor running for about 3 minutes.

4. With Dump Hose opened and positioned by floor drain, spray inside of vac tank with clean water moving hose in a circular pattern to ensure tank walls and float shutoff are rinsed.

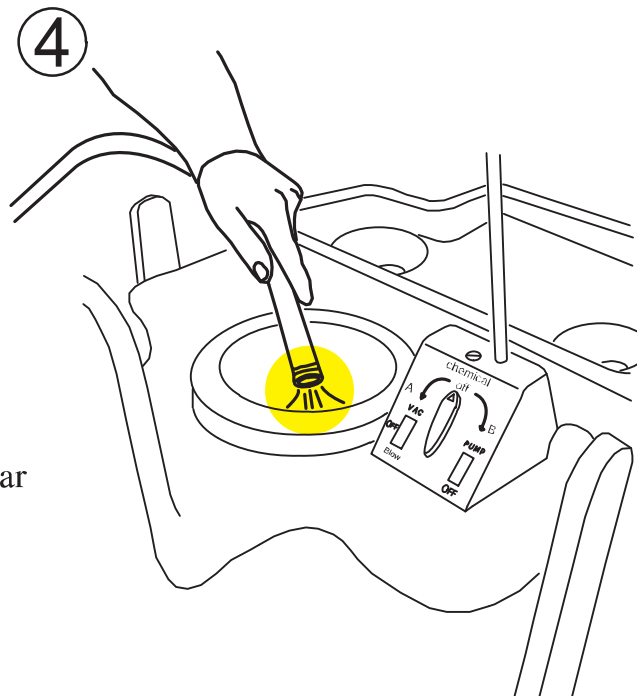

Kaivac Tool Arrangement

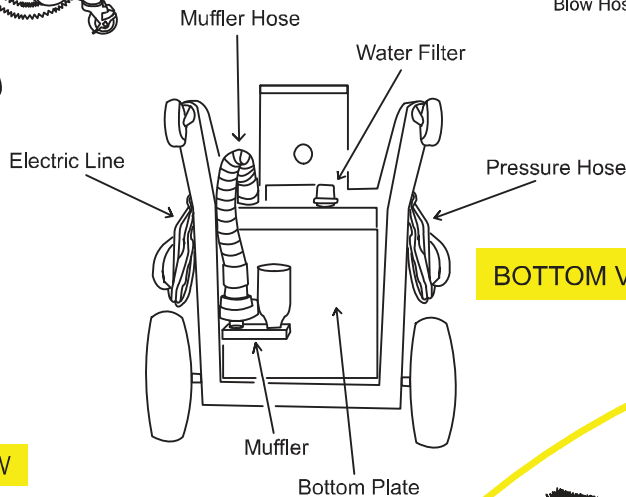
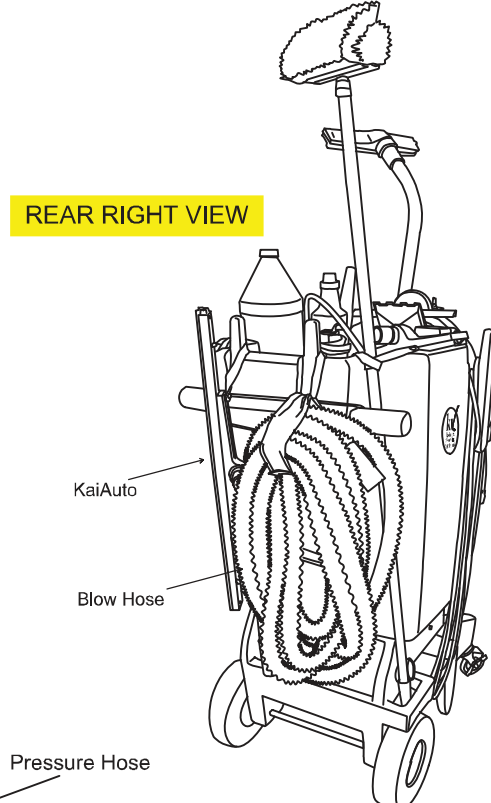
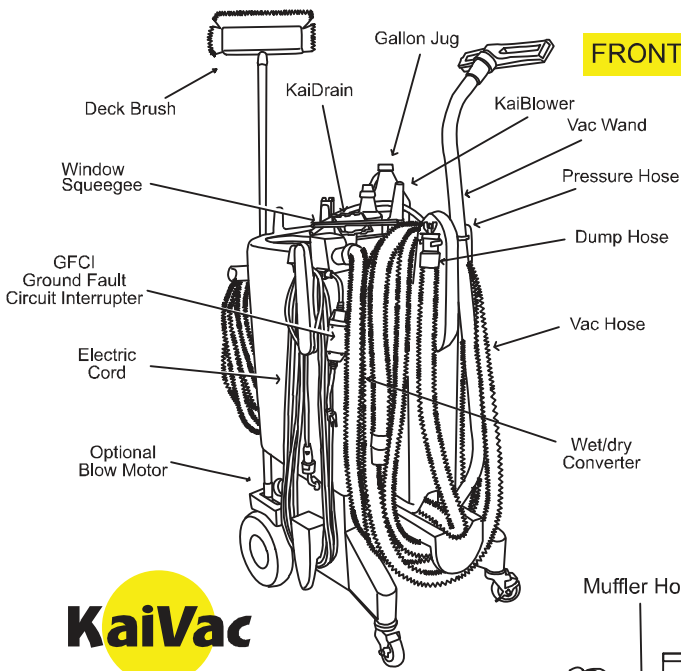

OVERHEAD VIEW

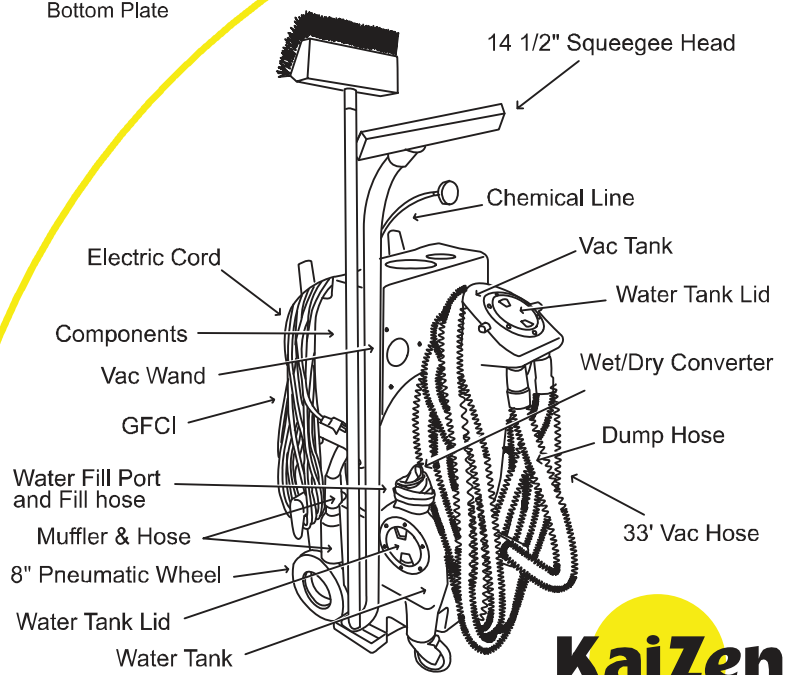
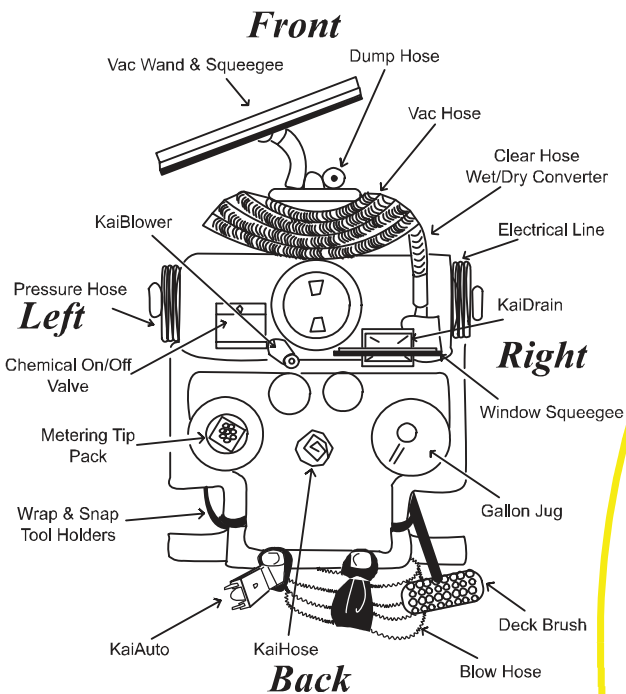



Restroom Closed for Cleaning



Caution

Wet

Floor



CAUTION

Always make sure machine is unplugged before lifting electrical cover assembly

Item	Procedure
Floor Squeegee	<ul style="list-style-type: none"> * Check condition of rubber squeegee blades and wheels on the floor tool. Rough floor surfaces will cause the blades and wheels to wear out more quickly. Replace as necessary.
Spray Gun	<ul style="list-style-type: none"> * Check spray pattern. If spray pattern will not pinpoint, clean orifice by removing it with an Allen wrench and flushing. Replace if not pinpointing. * If nozzle becomes difficult to move from high to low pressure lubricate nozzle with lithium grease.
Pressure Hose	<ul style="list-style-type: none"> * Wipe clean after each use. * Check for cuts or frays in the hose jacket, particularly at the end of the fittings. Replace hose if cuts are found.
Water Filter	<ul style="list-style-type: none"> * Check filter screens for debris and clean as needed. Be careful not to crush the end of the filter screen when replacing. * Check the clear filter bowl cover to be sure it is tight. * Check for leaks around filter and filter connections.
Water Tank	<ul style="list-style-type: none"> * Check condition of filter in water tank. Clean as needed. * Empty the water tank to prevent mildew and bacteria growth. Empty tank by dipping the vacuum hose onto the water tank and transferring the water to the vacuum tank.
Vacuum Tank	<ul style="list-style-type: none"> * Empty and flush vacuum tank. * Clean and disinfect. * Check the float shutoff screen to be sure it is not plugged up. A plugged filter screen restricts airflow and results in reduced suction.
Leaks	<ul style="list-style-type: none"> * Be alert for leaks around hoses, fittings, spray wand, tanks or elsewhere. Discontinue use until leaks are repaired.
Electrical System	<ul style="list-style-type: none"> * The ground fault circuit interrupter (GFCI) must be tested before each use. * Electric cords must be inspected for tears or cuts in the insulation.
DVD System	<ul style="list-style-type: none"> * Make sure DVD player is dry and free of any debris placed on top or inside of storage compartment.

TROUBLESHOOTING



KaiZen
No-Touch Cleaning™

Protected by U.S. Patent # 6,206,980; patents pending



CAUTION

Always make sure machine is unplugged before lifting electrical cover assembly

AREA	PROBLEM	POSSIBLE CAUSE	REMEDY
Electrical	No power to pump or vac motor.	<ol style="list-style-type: none"> 1. Machine not plugged in. 2. Switch not "on." 3. GFCI tripped. 4. Building circuit overloaded. 5. Switch wires loose. 6. Terminal block connections loose. 	<ol style="list-style-type: none"> 1. Plug machine in. 2. Check switches for "on." 3. Test and reset GFCI. 4. Check and reset circuit. 5. Disconnect power and check for loose wire. 6. Disconnect power and check for loose wire.
	Electrical burning smell.	<ol style="list-style-type: none"> 1. Vac motor brushes worn. 2. Vac motor hung up. 3. Pump motor hung up. 	<ol style="list-style-type: none"> 1. Replace vac motor brushes. 2. Remove vac motor and repair. 3. Release pressure on hose and jog pump switch, or replace.
Vacuum System	No/Weak vacuum.	<ol style="list-style-type: none"> 1. Vac tank full. 2. Squeegee blades or wheels worn. 3. Float shutoff screen dirty. 4. Float ball stuck. 5. Damaged hose. 6. Dump hose plug missing. 7. Access lid not tight. 8. Vacuum hose plugged. 9. Too much liquid in vac hose. 10. Vac hose still wrapped. 11. Muffler plugged. 12. Leak in vac tank. 	<ol style="list-style-type: none"> 1. Empty vac tank. 2. Replace wheels or blades and check periodically. 3. Wipe off float screen to clean. 4. Tap float and release/clean. 5. Cut and repair/replace. 6. Contact dealer and replace. 7. Tighten lid hand tight. 8. Flush hose to remove debris. 9. Allow air in when vacuuming. 10. Unwrap vac hose fully. 11. Remove padding and clean. 12. If repairable, clean and dry affected area and seal with silicone.
	Moisture from exhaust.	<ol style="list-style-type: none"> 1. Vac tank full. 2. Float shutoff missing. 3. Excessive foam in vac tank. 	<ol style="list-style-type: none"> 1. Dump vac tank. 2. Replace. 3. Use defoamer.
Blow Dry System	No air flow.	<ol style="list-style-type: none"> 1. Hose disconnected. 	<ol style="list-style-type: none"> 1. Reconnect hose.
	Moisture from nozzle.	<ol style="list-style-type: none"> 1. Water in blow hose. 	<ol style="list-style-type: none"> 1. Dry blow line.
	Suction not blow action.	<ol style="list-style-type: none"> 1. Vacuum hose connected to vac tank. 	<ol style="list-style-type: none"> 1. Reconnect to vac motor exhaust hose.
DVD System	No power.	<ol style="list-style-type: none"> 1. Power cord not connected 2. Power switch not on. 	<ol style="list-style-type: none"> 1. Plug cord into dvd player. 2. Turn switch on DVD player on.
	No picture	<ol style="list-style-type: none"> 1. Screen is blank. 	<ol style="list-style-type: none"> 1. Close and re-open lid. Play.
	No audio	<ol style="list-style-type: none"> 1. No sound from player 	<ol style="list-style-type: none"> 1. Check volume control knob.



CAUTION

Always make sure machine is unplugged before lifting electrical cover assembly

AREA	PROBLEM	POSSIBLE CAUSE	REMEDY
High Pressure System	No water from pump or low pressure.	<ol style="list-style-type: none"> 1. Out of water. 2. Gun nozzle plugged. 3. Air in pump (vapor lock). 4. Gun orifice missing. 5. Tank filter plugged. 6. In-line bowl filter plugged. 7. Bowl filter lid loose. 8. Pressure hose damaged. 9. Quick disconnect leaking. 10. Injector plugged. 11. Pulse hose damaged. 12. Regulator failed. 13. Hose kinked. 14. Seals in pump need replaced. 	<ol style="list-style-type: none"> 1. Fill water tank. 2. Remove orifice with Allen wrench and clean. 3. Use power prime technique. 4. Replace orifice. 5. Clean tank and filter. 6. Remove filter cover and clean. 7. Gently tighten bowl cover. 8. Repair or replace. 9. Tighten or replace. 10. Remove safety cap from chemical and blow small amounts of compressed air into line. 11. Repair or replace. 12. Replace. 13. Unkink and check for damage 14. Remove and replace seals.
	Bad fan pattern or pinpoint pattern on gun.	<ol style="list-style-type: none"> 1. Debris in nozzle. 2. Orifice damaged. 	<ol style="list-style-type: none"> 1. Remove orifice with Allen wrench and clean. 2. Remove and replace.
Chemical Injection System	No chemical flow.	<ol style="list-style-type: none"> 1. Out of chemical. 2. Safety cap not secure. 3. Chemical valve "off." 4. Safety cap plugged. 5. Spray gun in wrong mode. 6. Metering tip plugged. 7. Injector plugged. 8. Air entering system. 9. Injector installed backwards. 	<ol style="list-style-type: none"> 1. Refill chemical. 2. Check safety cap / tighten. 3. Check on / off valve. 4. Replace cap. 5. Make sure gun nozzle is pulled out away from gun chemical mode. 6. Check metering tip for clog. 7. Remove safety cap from chemical and blow small amounts of compressed air into line. 8. Check for air entering system around chemical lines or injector. 9. If fluttering or pulsing sound can be heard while spraying or when machine is running it is possible that your injector is in backwards. Remove and reinstall.

TROUBLESHOOTING



Protected by U.S. Patent # 6,206,980; patents pending

CAUTION

Always make sure machine is unplugged before lifting electrical cover assembly

AREA	PROBLEM	POSSIBLE CAUSE	REMEDY
Chemical Injection System Con't.	Not enough chemical flow.	<ol style="list-style-type: none"> 1. Metering tip plugged. 2. Wrong metering tip. 	<ol style="list-style-type: none"> 1. Remove and clean. 2. Check and replace per chart.
	Chemical line blows off safety cap.	<ol style="list-style-type: none"> 1. Debris in injector. 	<ol style="list-style-type: none"> 1. Remove safety cap from chemical and blow small amounts of compressed air into line.
	Water backflows into chemical bottle.	<ol style="list-style-type: none"> 1. Bad seat on injector check valve. 2. Bad safety cap. 	<ol style="list-style-type: none"> 1. Check injector o-ring or replace. 2. Replace safety cap.
Dump System	Dump hose will not empty tank.	<ol style="list-style-type: none"> 1. Dump hose plug not removed. 2. Clog in bottom of tank. 	<ol style="list-style-type: none"> 1. Remove plug. 2. Tip dump contents, remove debris.
	Dump hose leaks.	<ol style="list-style-type: none"> 1. Hose cut. 2. Clamp loose. 3. Dump plug bushing missing. 4. Plug missing. 	<ol style="list-style-type: none"> 1. If leak is less than 4" from tank side, cut and reattach, or replace. 2. Tighten hose clamp. 3. Replace bushing. 4. Replace plug.
Wheels and Casters	Wheels won't roll, or they rub.	<ol style="list-style-type: none"> 1. Flat tires. 2. Debris wrapped around axle. 3. Bearings tight. 4. Wheels too loose on axle. 5. Bearings falling out. 	<ol style="list-style-type: none"> 1. Inflate tires to 30 psi. 2. Check for debris on axle. 3. Grease bearings. 4. Remove wheel, add washers to take up slack. 5. Refer to remedy 4.
Squeegee Head	Floor streaks.	<ol style="list-style-type: none"> 1. Worn blades or wheels. 	<ol style="list-style-type: none"> 1. Replace wheels and / or blades.
	Squeegee head doesn't easily rotate when installed on wand.	<ol style="list-style-type: none"> 1. Brass ring on wand not in groove. 2. Coupling nut too tight. 	<ol style="list-style-type: none"> 1. Loosen coupling nut and reposition head on groove. 2. Loosen 1/2 turn.
	Head won't stay on wand.	<ol style="list-style-type: none"> 1. Coupling nut cracked. 2. Brass ring worn. 	<ol style="list-style-type: none"> 1. Replace. 2. Replace.
	Premature blade wear.	<ol style="list-style-type: none"> 1. Squeegee wheels worn. 	<ol style="list-style-type: none"> 1. Check wheels for wear / replace.
	Sucks to the floor too tightly.	<ol style="list-style-type: none"> 1. Squeegee wheels worn. 	<ol style="list-style-type: none"> 1. Check wheels for wear / replace.

Chemical Injection Chart



METERING TIP CHART

TIP	PSI	OZ Per Gallon
• Black	300/500	1.25 / 2
• Aqua	300/500	3.00 / 4
• Orange	300/500	4.75 / 5
• Tan	300/500	9.50 / 10
• None	300/500	35 / 40

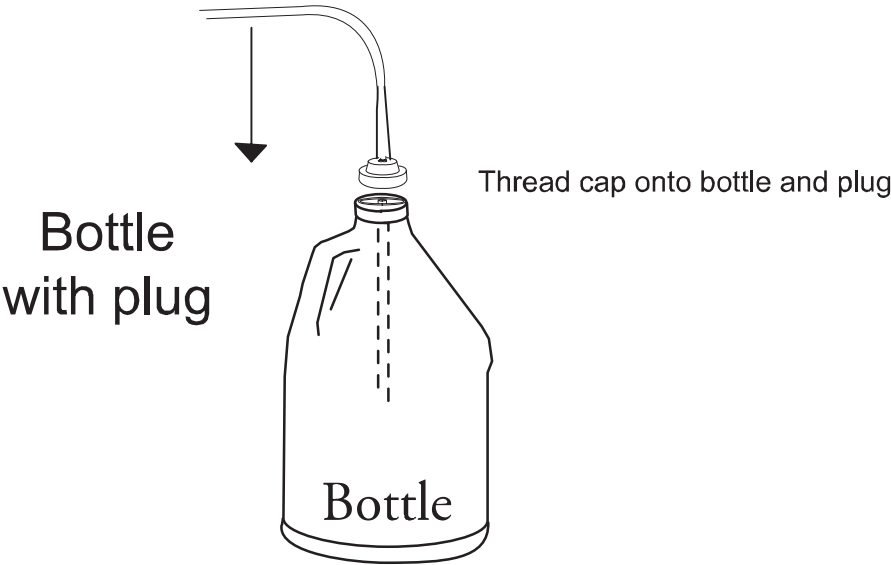
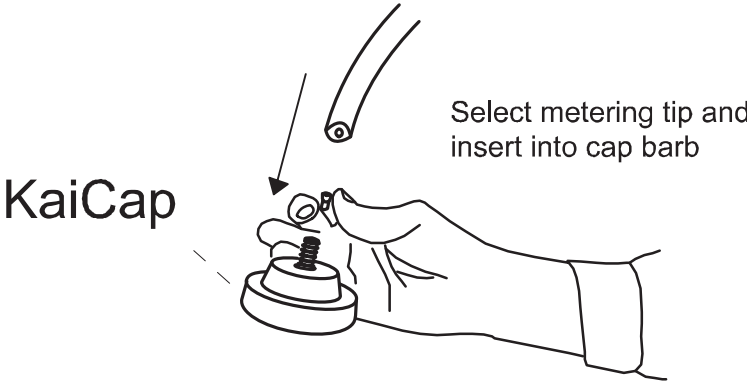

FLOW DIAGRAM

VACUUM SYSTEM

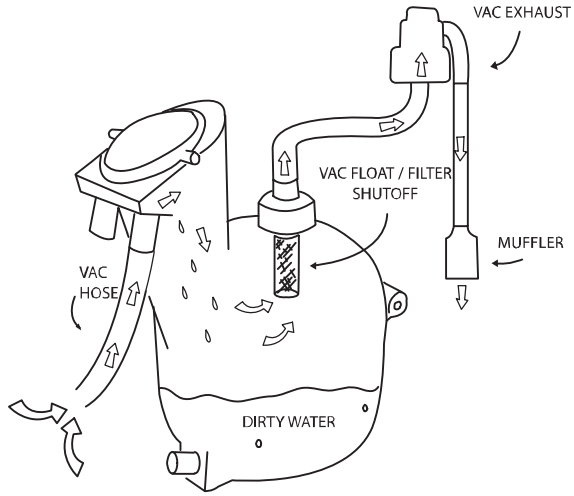

LIQUID SYSTEM

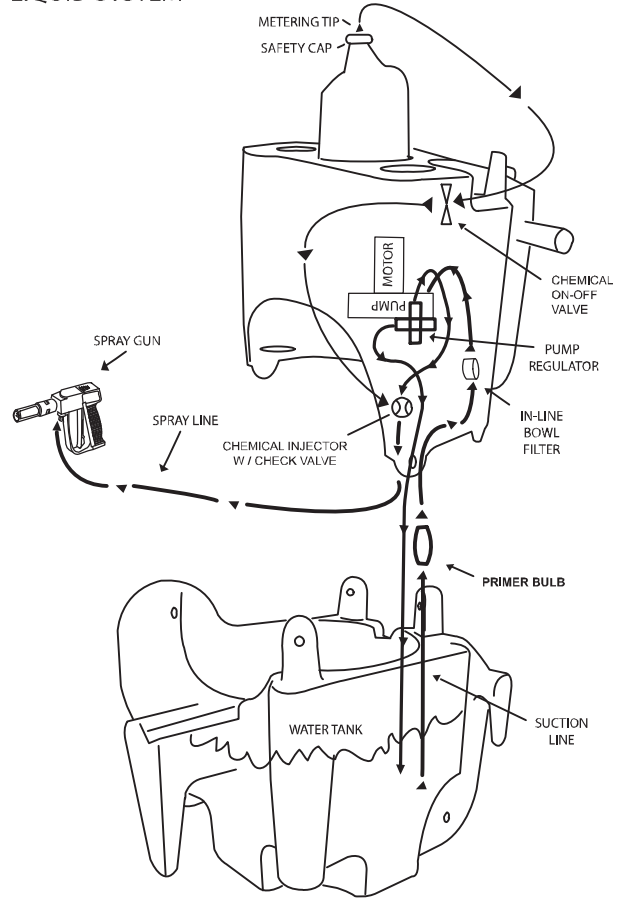

ELECTRICAL DIAGRAM

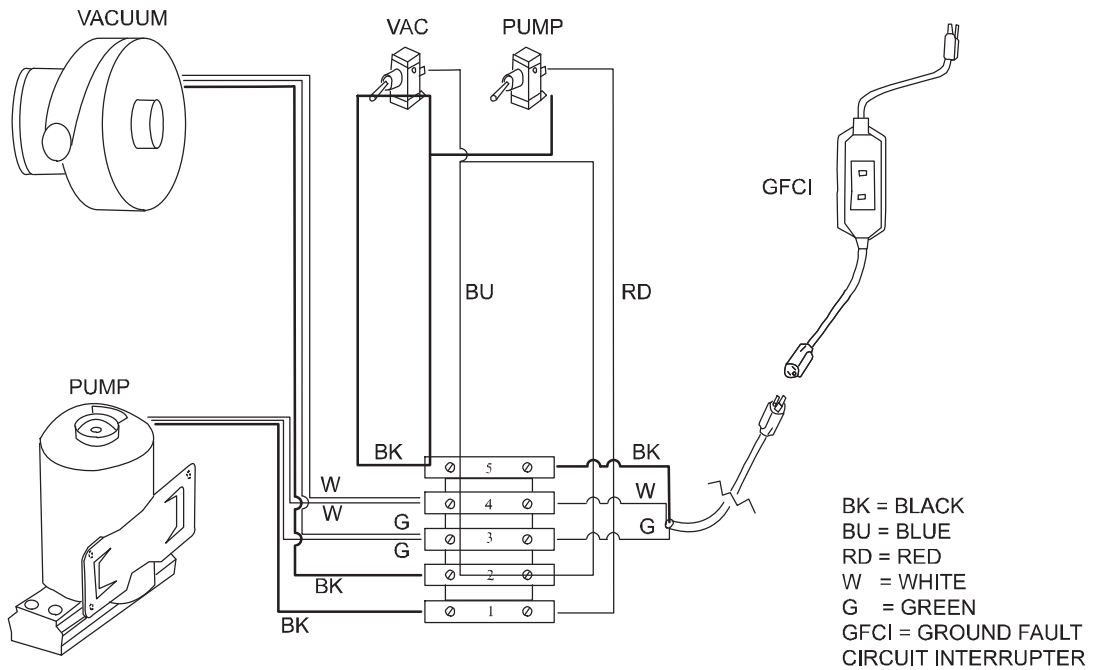

KaiZen Parts List

#	PART #	PART DESCRIPTION
		<u>WATER TANK FIG. #1</u>
1	KZ001	WATER TANK ONLY
	SUBWTKZP	WATER TANK ASSEMBLY
2	CFS02	CASTERS
2a	CSS92	5/16 X 1 CASTER MOUNT BOLTS
3	KZAXLE	KaiZen Axle
4	CSS46	5/8 WASHERS
5	KW01458	8" PNEUMATIC WITH 5/8 HUB
6	CSS72	COTTER PINS
7	CSS43	5/8 PUSH CAP NUT
8a	CVS06V	LARGE BECKSON LID
8b	GAS02	GASKET
9	CSS17A	BECKSON LID SCREWS
10	CSS88	1/4 X 3/4 BOLT
11	CSS44	1/4" WASHER
11a	TRAY	KAIZEN TRAY
12	MUFPAD	MUFFLER PAD
13	CSS75	1/4 X 3 1/2" MUFFLER BOLT
14	CSS44	1/4" WASHER
15	CSS14	# 13 BECKSON CLIP
16	CSS17	SQUARE DRIVE SCREW
17	CSS91	3/8 X 2 1/4 SST BOLT
18	CSS57	3/8 X 3/4 SST BOLT
19	KMB16	3/8 WASHERS
		<u>VAC TANK FIG.#2</u>
20	KZ002	NEW VAC TANK
21	CVS06V	LARGE BECKSON LID
21b	GAS02	GASKET
22	CSS17A	BECKSON LID SCREWS
23	DHKWIZ	KAIZEN DUMP HOSE
24	CVS08A	DUMP HOSE CUFF
25	CSS21A	DUMP HOSE CLAMP
26	SUBFLKW	FLOAT
26a	CPS20	3/8 X 1/2 BARB
26B	1"1/2 VACHOSE	HOSE
26C	PREMUFF	PRE-MUFFLER
26d	CSS63	TIE STRAP
26e	CVS28	FILTER BAG
		<u>COVER FIG.#3</u>
27	KZ003	COVER
28	CVS01C	VAC MOTOR FOR NON-QUIET MODELS ONLY
	CVS01B	VAC MOTOR FOR QUIET MODELS ONLY
29	DHKWIZ	VAC INLET LINE

29A	CVS40	INLET RETAINER
30	CSS21	CLAMP
31	MUFPAD	MUF PAD
32	CSS09	1/4 X 5 1/2 BOLT
33	CSS77	1/4 X 2 1/2 BOLT
34	CSS44	1/4" WASHERS
35	CSS27	1/4" NYLOC NUTS
36	SUBMFKW	EXHAUST HOSE
37	CSS17A	EXHAUST RETAINER SCREW
38	CES10	TERMINAL BLOCK
39	CSS17B	TERMINAL BLOCK SCREW
40	CSS08	PUMP MOUNT NUTS
41	CSS92	5/16 X 1 PUMP MOUNT BOLTS
42	PUMPKZ	PUMP MOTOR
42b	RECT	AC/DC RECTIFIER
43	SWPL	SWITCH PLATE ONLY
44	CSS17A	SWITCH COVER SCREWS
45	CES02B	ROCKER SWITCHES
46	CES03	30" ELECTRIC WIRE
47	CEA04	MALE PLUG END
48	CSS50	RUBBER GROMMET
49	CPS75	CORD RETAINER
50	CSS11	RETAINER SCREW
51	CSS14	#13 BECKSON CLIPS
52	CSS17	SCREWS
53	CPS43A	2 WAY BRASS VALVE
54	CPS68	1/8 NPT X 1/4 BARB 90 DEG.
55	CSS21	CLAMP
56	CPS01	20 X 1/4 BRAIDED HOSE
57	CPS01	24 X 1/4 BRAIDED HOSE
58	CHCAP	CHEMICAL CAP
59	CPS65	1/2 RESTRICTER CLAMP
60	CPS12JQC	QUICK CONNECT INJECTOR
61	CPS39	3/8 COUPLING
62	CSS108	RUBBER CUSHIONED STEEL STRAP
62b	CSS103	SCREW
63	CPS38	3/8 MALE QD PLUG
64	CPS01	32" 1/4 BRAIDED RETURN LINE
65	CSS21	CLAMP
66	CPS09	10" 1/2 WIRE REINFORCED HOSE
67	CPS54	FILTER
68	CPA09	1 - PRIMER VALVE
68A	CPS85	1 - REDUCER 1/4M X 1/8M
68B	CPS86	1 - ADAPTER 1/8M X 1/4F
68C	CPS87	1 - 1/4 NPT X 1/2 BARB
68D	CPS71	2 - 1/4 90 DEG. ELBOW
69	CPS84	90 DEGREE BRASS FITTING (FEMALE)
70	CSS64	TIE STRAPS
72	CPS09	16" 1/2 WIRE REINFORCED
73	CPS33	1/4" CLOSE NIPPLE

74	CSS91	3/8 X 2 1/4 BOLTS
75	KMB16	3/8 WASHERS
76	CSS26	3/8 X 1 1/2 BOLTS
77	CSS45	POLYP WEBBING
78	CSS20	SNAP STUD
79	CSS19	SNAP SOCKET
80	CSS18	SNAP BUTTON
81	CSS11	SCREW

COVER FIG.#4 COVER KAIZEN 500psi/Blow Motor		
1A	KZ003	COVER
1	CVS01C	VAC MOTOR
2	DHKWIZ	VAC INLET LINE
3	CSS21B	CLAMP
4	MUFPAD	MUF PAD
5	CSS09	1/4 X 3 1/2 BOLTS
6	CSS77	1/4 X 2 1/2 BOLT
7	CSS44	1/4" WASHERS
8	CSS27	1/4" NYLOC NUTS
9	SUBMFKW	MUFFLER HOSE
10	CSS17A	SCREW
11	CES10	TERMINAL BLOCK
12	CSS17B	TERMINAL BLOCK SCREW
13	CSS08	PUMP MOUNTS
14	CSS92	5/16 X 1 FLANGE BOLTS
15	SUBPA	PUMP
16	SWPL	SWITCH PLATE ONLY
17	CSS17A	SWITCH COVER SCREW
18	CES02B	ROCKER SWITCHCH
19	CES02C	3 WAY SWITCH
20	CVS01B	BLOW MOTOR
22	CSS75	1/4 20 X 3 1/2 SST BOLT
23	CSS44	1/4" WASHER
24	CSS27	1/4" NYLOC NUT
25	CES03	30" ELECTRICAL CORD
26	CEA04	MALE PLUG END
27	CSS50	RUBBER GROMMET
28	CPS75	CLAMP
29	CSS11	SCREW FOR CLAMP
30	CSS14	#13 BECKSON CLIPS
31	CSS17	3/4 SQUARE DRIVE SCREW
32	CPS43A	2 WAY BRASS VALVE
33	CPS68	1/8" NPT X 1/4 BARB 90 DEG.
34	CSS21	SNAP GRIP HOSE CLAMP
35	CPS01	20" 1/4 BRAIDED HOSE
36	CPS01	24" 1/4 BRAIDED HOSE
37	CHCAP	CHEMICAL CAP
38	CPS65	1/2 " RESTRICTER CLAMP
39	CPS12JQC	QUICK CONNECT INJECTOR
39b	CPS38	3/8 MALE QD PLUG

39c	CSS108	RUBBER CUSHIONED STEEL STRAP
39d	CSS103	SCREW
40	CSS21	SNAP GRIP CLAMP
41	CPS78	3/8F X 3/8F COUPLER
42	CPS01	1/4 BRAIDED HOSE
43	CSS21	SNAP GRIP CLAMP
44	CPS09	10" 1/2 WIRE REINFORCED HOSE
45	CPS54	FILTER
46	CPS09	8" 1/2 WIRE REINFORCED HOSE
47	CPS10	7/16 X 25/32 CLAMP
48	CSS64	TIE STRAPS
50	CPS09	16" 1/2 WIRE REINFORCED
51	CPS10	7/16 X 25/32 CLAMP
51a	CPA09	1 - PRIMER VALVE
51c	CPS85	1 - REDUCER 1/4M X 1/8M
51d	CPS86	1 - ADAPTER 1/8M X 1/4F
51e	CPS87	1 - 1/4 NPT X 1/2 BARB
51b	CPS71	2 - 1/4 90 DEG. ELBOW
52	CSS91	3/8 X 2 1/4 BOLTS
53	KMB16	3/8 WASHERS
54	CSS26	3/8 X 1 1/2 BOLTS
55	CSS45	POLYP WEBBING
56	CSS20	SNAP STUD
57	CSS19	SNAP SOCKET
58	CSS18	SNAP BUTTON
59	CSS11	SCREW
		<u>STANDARD ACCESSORIES</u>
	SUBPHKV	PRESSURE HOSE ASSEMBLY FOR KAIZEN
	SUBGAKW	SPRAY GUN
	CAS01A	YELLOW DECK BRUSH
	CAS02A	BRUSH HANDLE
	CAA06	WINDOW SQUEEGEE
	CVS13	BLOW NOZZLE
	CVS14	KAIDRAIN
	SUBFHB	FILL HOSE ASSEMBLY
	CVS12S	14 1/2 VACUUM HEAD SQUEEGEE TOOL W/SS WHEELS
	CVS11	ALUMINUM VACUUM WAND
	SUBVW	VACUUM WAND & SQUEEGEE HEAD COMPLETE
	CES20	EXTENSION CORD
	CES19	GFCI CORDSET
	MTIPSNEW	METERING TIP PACK
	VHKVJR	33' VACUUM HOSE ASSEMBLY
		<u>KAIZEN 500psi and Blow Motor</u>
	SUBGA	SPRAY GUN
	SUBBLHS	33' BLOW HOSE
		<u>SQUEEGEE TOOL</u>
	STEEL	STAINLESS STEEL WHEEL

	CAA07	PLASTIC WHEEL
	CAA08	WHEEL HOLDER
	CAA09	HOLDER SCREW
	CVA03	SQUEEGEE BLADE
	CVA16	TOOL COUPLING
	CVA14	METAL RING
	CVA15	COUPLING NUT
	CAA10	GLIDES

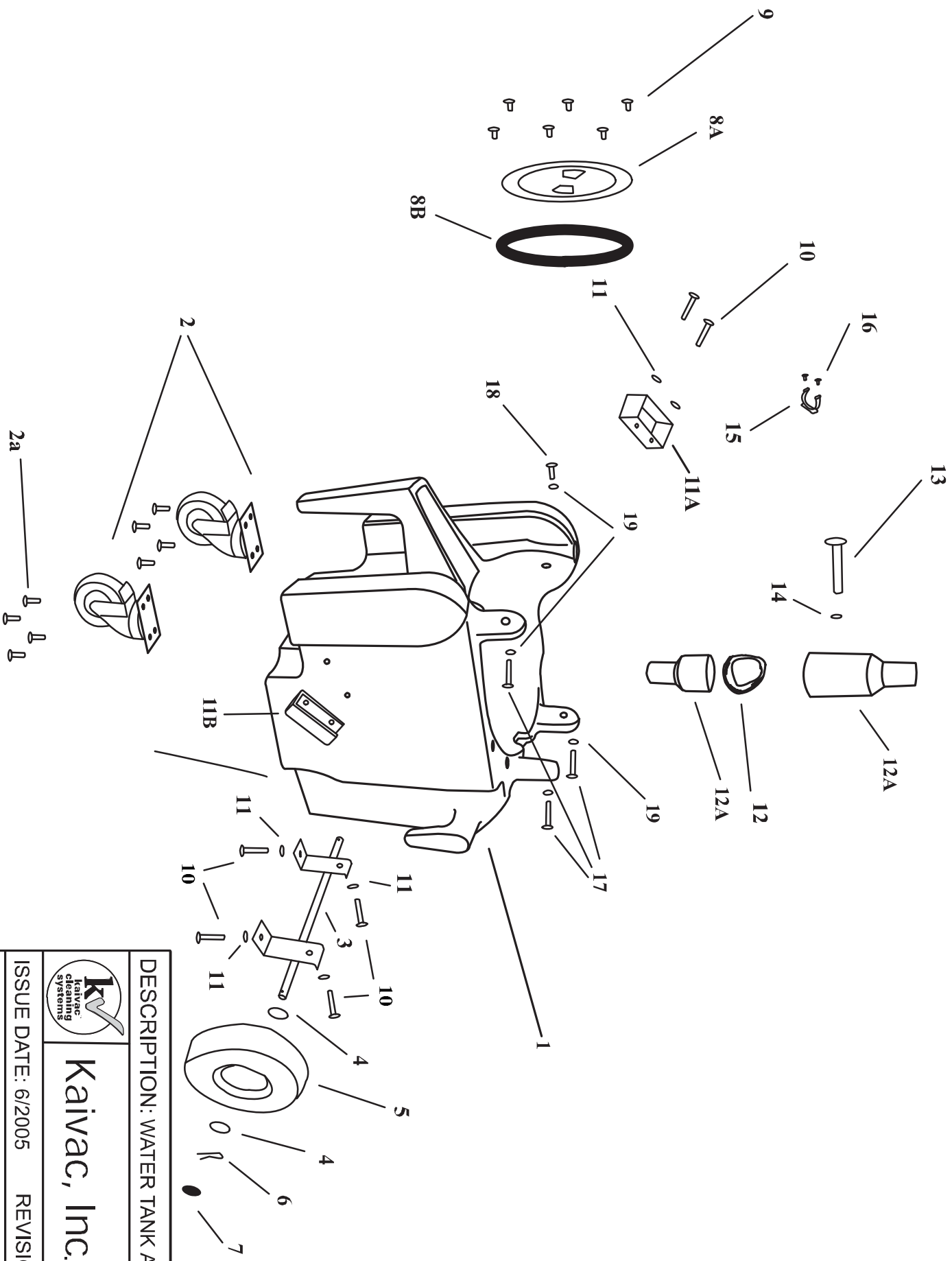

	
Kaivac, Inc.	
DESCRIPTION: WATER TANK ASSEM.	
ISSUE DATE: 6/2005	REVISION: C
FIG# 1 KAIZEN	SHEET 1 OF 1

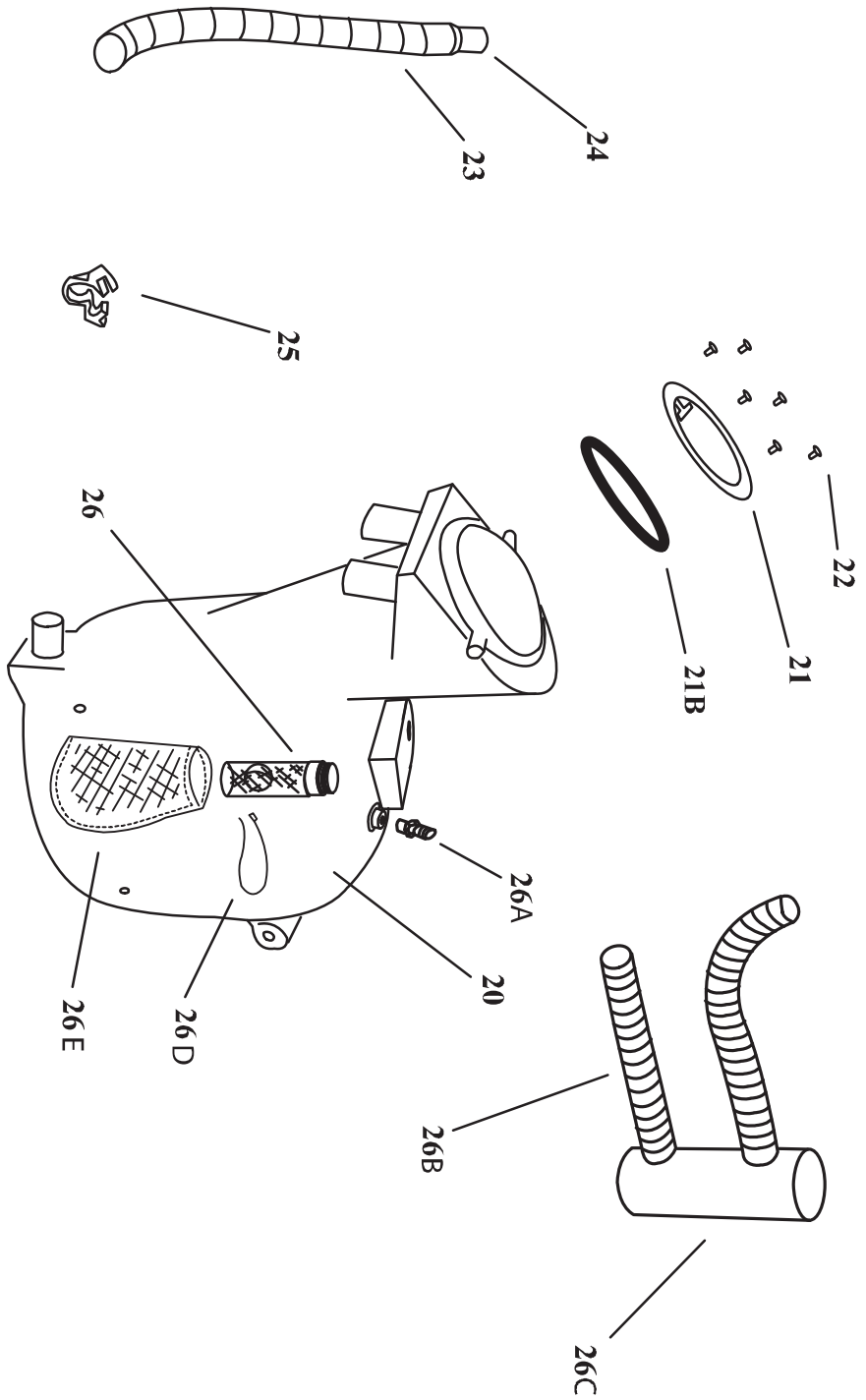

DESCRIPTION: VAC TANK



Kaivac, Inc.

ISSUE DATE: 10/2002 REVISION: C

FIG# 2 KAIZEN SHEET 1 OF 1

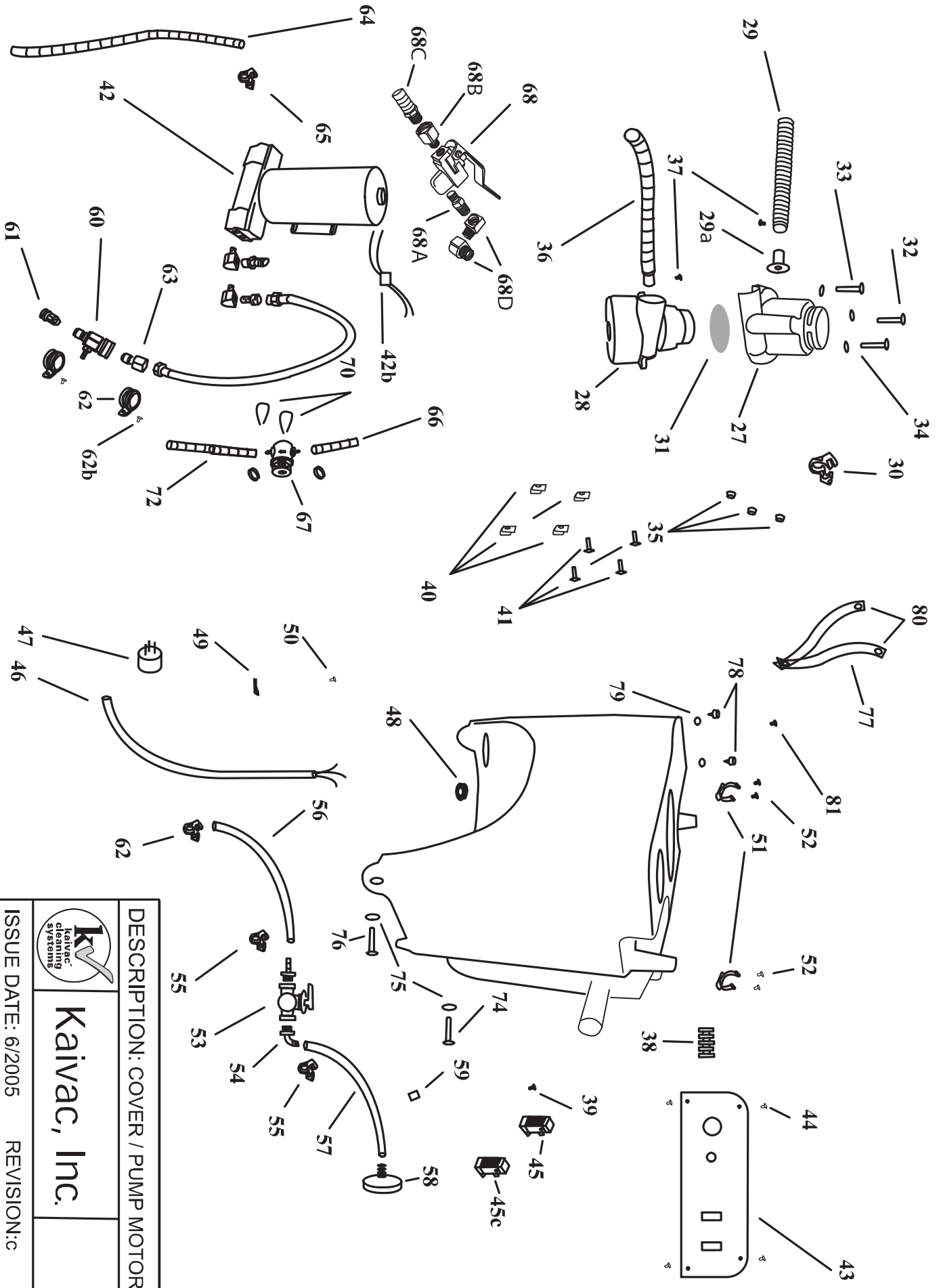

*** FOR KAIZEN PLUS COVER PARTS PROCEED TO FIG.#4**

	Kaivac, Inc.
ISSUE DATE: 6/2005	REVISION: c
FIG# 3 KAIZEN	SHEET 1 OF 1

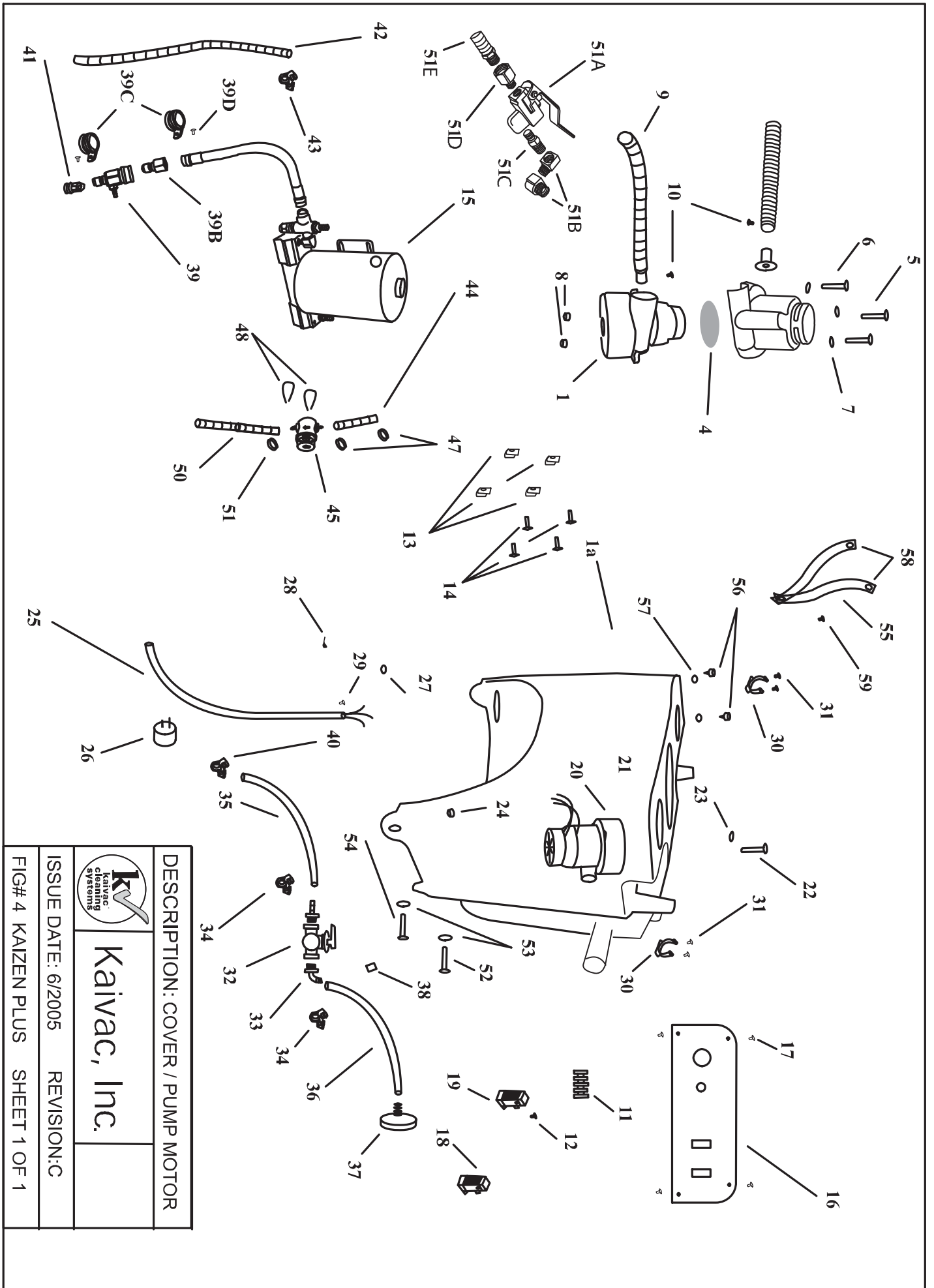

	DESCRIPTION: COVER / PUMP MOTOR	
	Kaivac, Inc.	

ISSUE DATE: 6/2005 REVISION: C

FIG# 4 KAIZEN PLUS SHEET 1 OF 1

PAGE DIVIDER